



„Resonant Pipes,“

Sophia Drevenstam

Hello,

A pipe, when used for creating sound through the flow of air is called a tubular wind instrument.

A traditional wind instrument is the flute, which produces sound by focusing air into a mouthpiece, causing the air column in the resonator body to vibrate. The player changes the pitch of the sound produced by opening and closing holes in the body of the instrument, thus changing the effective length of the resonator and its resonant frequency. While blowing air into the mouthpiece, simultaneously closing a hole, affects the length of the sound wave produced, and in turn, creates a sound with a higher frequency and therefore a higher pitch. A frequency is the number of sound wave occurrences of a repeating event per unit time.

There are many variations of tubular wind instruments found throughout the world, with the oldest found being a flute dating back to 43,000 years ago. It varies in material; animal bones, wood, bamboo and in modern times plastic and metals.

But you don't need a literal mouth to blow air directly into the mouthpiece in order to create resonance. Anything that can blow air into the resonance body will suffice. As in the case of the pipe-organ, where fingers are striking keys, or the feet striking pedals, which in turn strikes the pipes causing the resonance to be created by airflow, which in turn creates the sound that we hear.

Plastic PVC pipes are commercially used for plumbing, in areas where flowing substances (water, waste, chemicals) need to be conveyed. These pipes can be found in a large variety of diameters, lengths and angles, and can be easily screwed on and off each other. These pipes can be used to create sound by adding or subtracting its length, the longer the pipe, the longer the wavelength, which allows for a static note to be played.

When working with resonance, there are variables that affect the pitch and the tone color (timbre). The material the pipe is made of affects the tone color; a wooden pipe will sound different than a brass pipe, even if the length and therefore the pitch is the same. So does the material that is used for the airflow, a metal paddle will have a different tone color than a rubber paddle. The length, as mentioned, affects the pitch and can be calculated using the wavelength of the frequency that should be attained.

This rudimentary way of creating sound through pipes allows for hands-on experiments, as it is so simple to create and play around with. Because of the angles available, the pipes do not need be straight and the resonance body can be built to be more 3-dimensional.

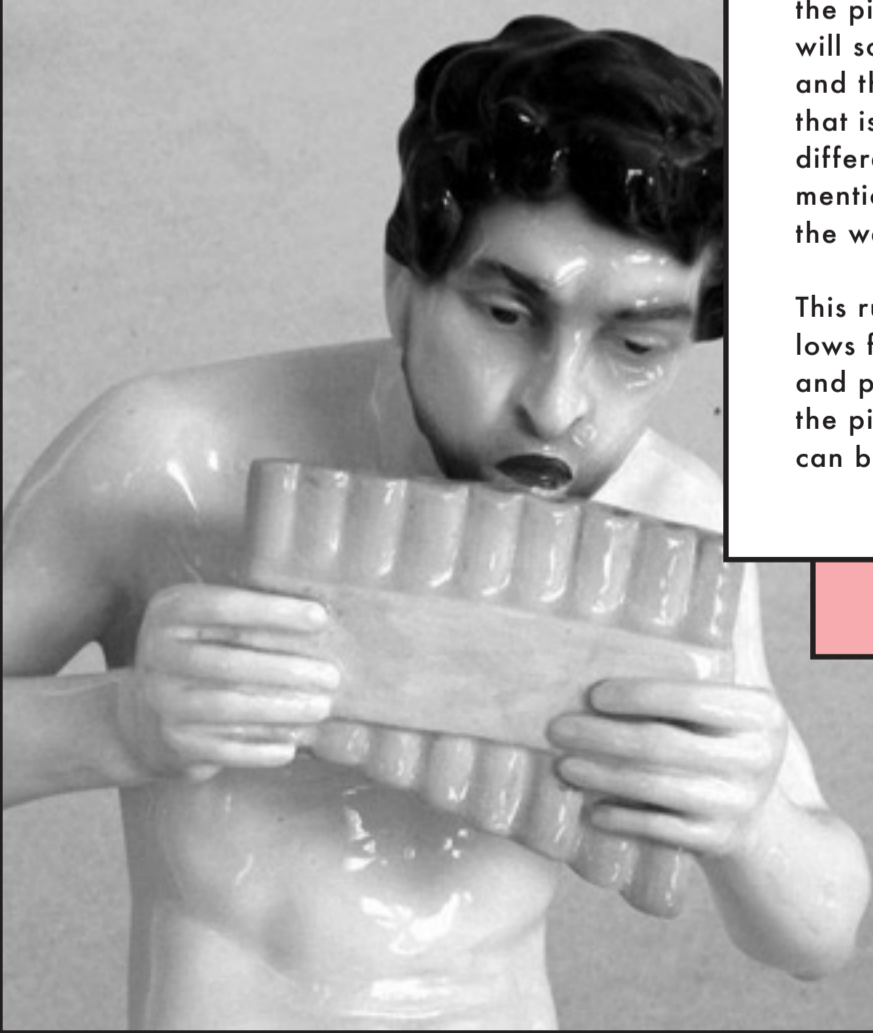

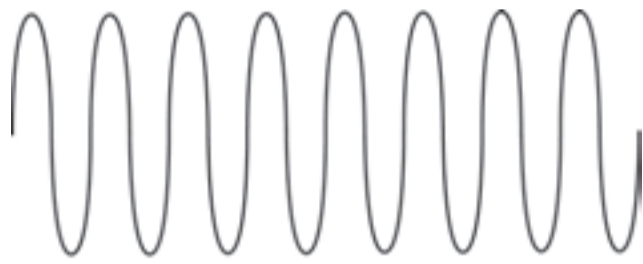

High frequency
sound wave



Low frequency
sound wave

The length needed to generate a specific note can be decided by looking at the wavelength of the note.

A wavelength of a tone is the distance over which the waves shape repeats. A frequency is the number of occurrences of a repeating event per unit time.

Higher frequencies repeat more often within the unit time than lower frequencies. The higher the frequency, the shorter the wavelength. There are ten octaves on a musical scale, the lower the octave, the lower the frequency and the longer the wavelength.

The note C in the Octave 0 has a wavelength of 20.812m, in the 4th Octave, 1.301m, and in the 9th and highest Octave, 0.041m

Construction: Lengths and notes

When working with resonance, there are variables that affect the pitch and the tone color (timbre). The material the pipe is made of affects the tone color; a wooden pipe will sound different than a brass pipe, even if the length and therefore the pitch is the same. So does the material that is used for the airflow, a metal paddle will have a different tone color than a rubber paddle. The length, as mentioned, affects the pitch and can be calculated using the wavelength of the frequency that should be attained.

An example of lengths needed for 6 different notes in the 3rd Octave:

Note C - 260.1 cm

Note D - 230.18 cm

Note E - 206.5 cm

Note F - 194.9 cm

Note G - 173.6 cm

Note A - 154.7 cm

Note B - 137.8 cm

Example of sizes commercially available to create the notes in the 4th Octave:



45 degrees

90 degrees

75 cm



50 cm



25 cm



15 cm



Construction: Visual / stability

I tried arranging the pipes in several different ways, to achieve enough stability for the pipes to be playable (ie. not fall apart or topple over when struck with paddles), but i also wanted the resonance body to have a 3 dimensional, sculptural quality, with the pipes not straight, but angled, almost as if they were knotted.

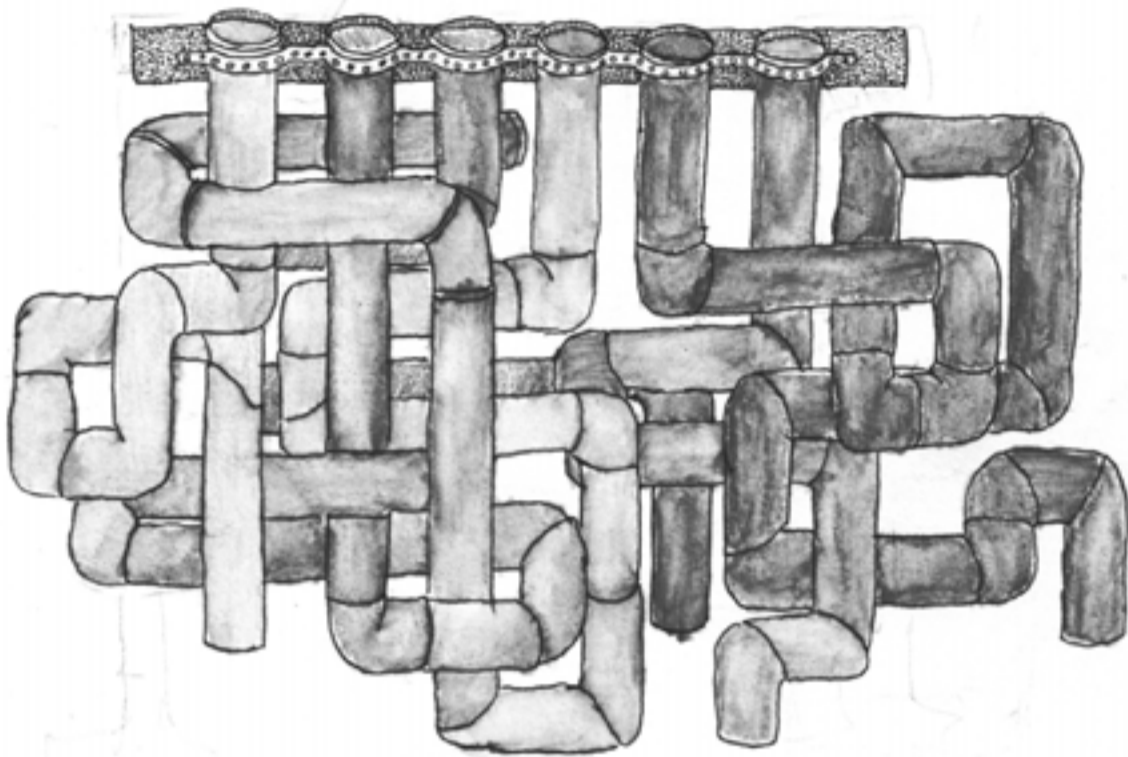

Version 1

Fastened horizontally the top end of each pipe onto a stand. This provided stability to the resonance body but it was not the look that i wanted.

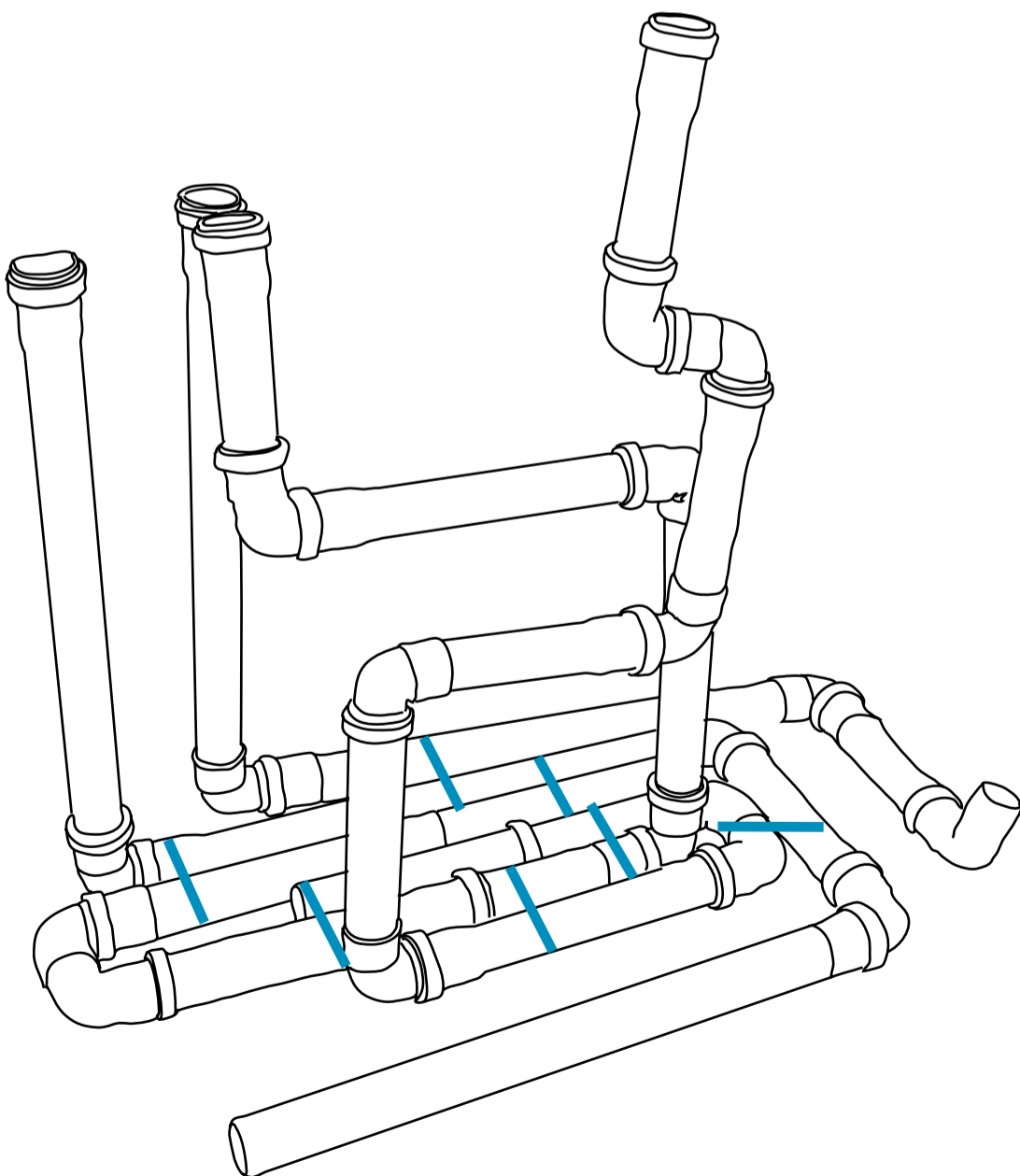

Version 2

Curved in a U-shape at the bottom in order to have balance and stability. Tied together with plastic wires for additional support. Having such large parts of the pipes placed onto a floor effected the sounds of the pipes negatively as it disrupts the sound wave.

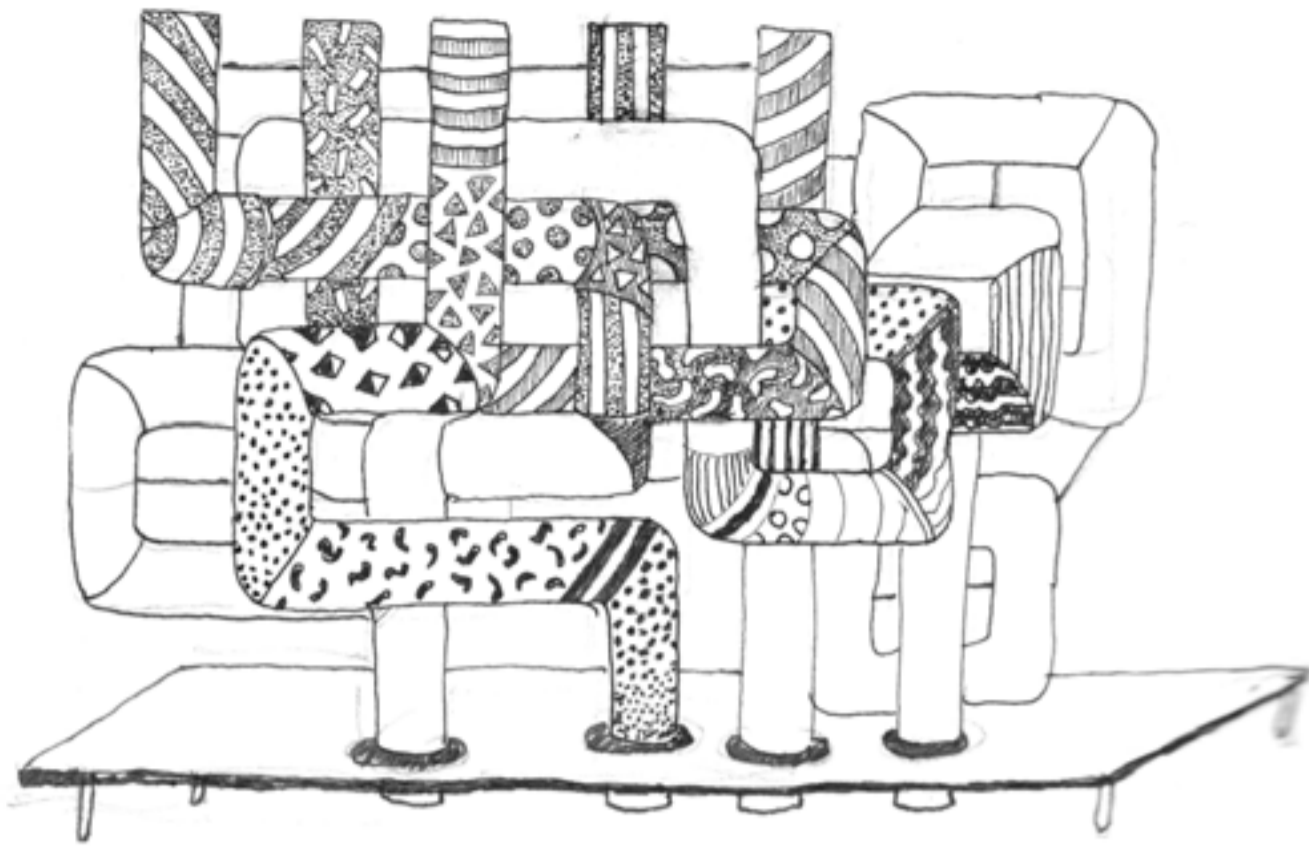

Version 3

(Fastened in holes through a table)

This table fastening provided stability, although the height of the pipes needed to be kept low as to keep the balance of the pipes. The top end of the pipes swing a little when struck with the paddle, and this slight vibration turned out to create a louder sound.

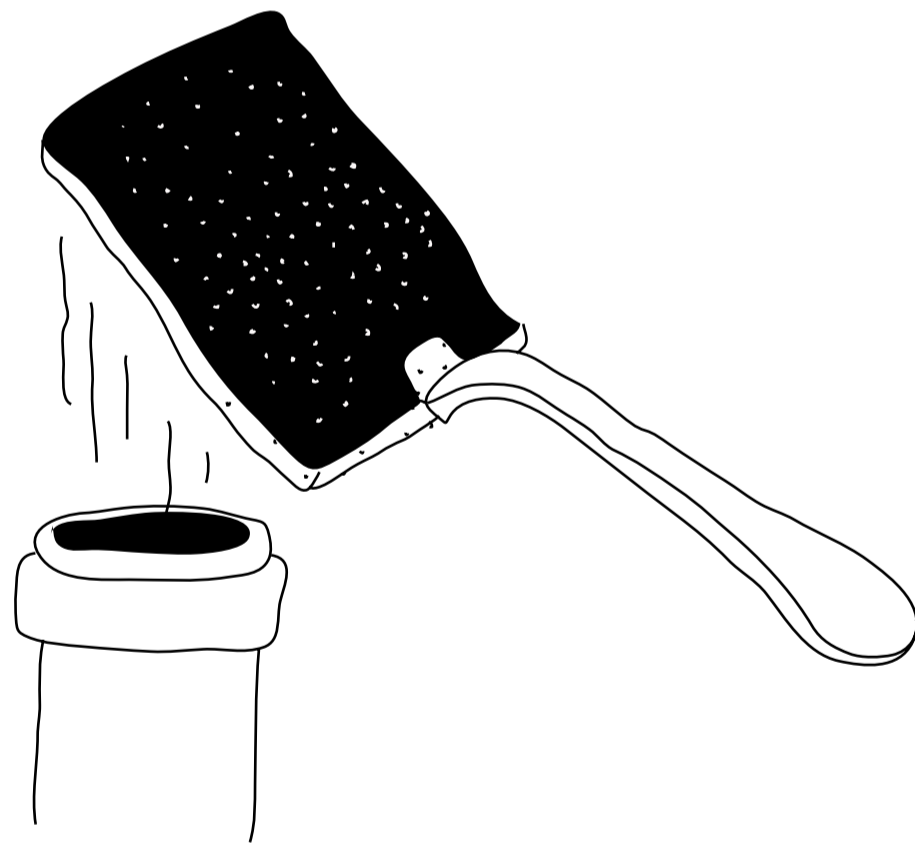

Striking air into the top causing a flow of air to enter the pipe, thus creating the sound.

The paddle is made out of a 5mm thick Polyethylene soft foam board, fastened onto a plastic handle.



A playful vision

(Because we are studying surface design after all)

Yes, diy pvc pipe instruments are nothing new. So i wanted my version to be set apart, to make it my own. I might not be technically skilled in product design, but i knew i could set it apart by using surface design, and i wanted to get away from the grey shade of the pvc pipe and make it look as fun as they sound. I a resonance body that looked playful and inviting, while not obscuring the pipes themselves.

Perhaps they pipes have now been turned into singing submarines or.. why not, a castle for Snow-white?

Woop woop

«Woop woop» ist eine grobe Beschreibung für die akustischen Töne, die durch Bewegung von Plastikplatten entstehen. Acrylglas oder auch organisches Glas (wissenschaftlich Polymethylmethacrylat) besteht aus thermoplastischem Harz.

Organisches Glas wurde im Jahr 1928 im Flugzeugbau eingesetzt. Die breite Anwendung fand durch die günstigen Materialeigenschaften wie dem sehr hohen Grad an Durchsichtigkeit sowie dem Bruchwiderstand statt. Darüber hinaus verfügt Acrylglas über ein hohes Mass an Wasserbeständigkeit und Umweltbelastbarkeit sowie eine geringe Materialmüdigkeit. Außerdem ist es gekennzeichnet durch einen sehr hohen Koeffizient der Schallabsorption.

Durch die besondere Eigenschaft, insbesondere die Elastizität des Materials, können bei der Bewegung einer Acrylglasplatte spezifische Töne entstehen. Eine optimale Wanddicke von 2 mm sowie eine minimale Länge von 500 mm sind erforderlich. Dabei soll die Breite weniger als die Hälfte von der Länge sein. Dadurch wird eine größere Schwankungsamplitude erreicht, was einen lang anhaltenden Klang ermöglicht.

Das Schema von Bewegungsmöglichkeiten des Materials

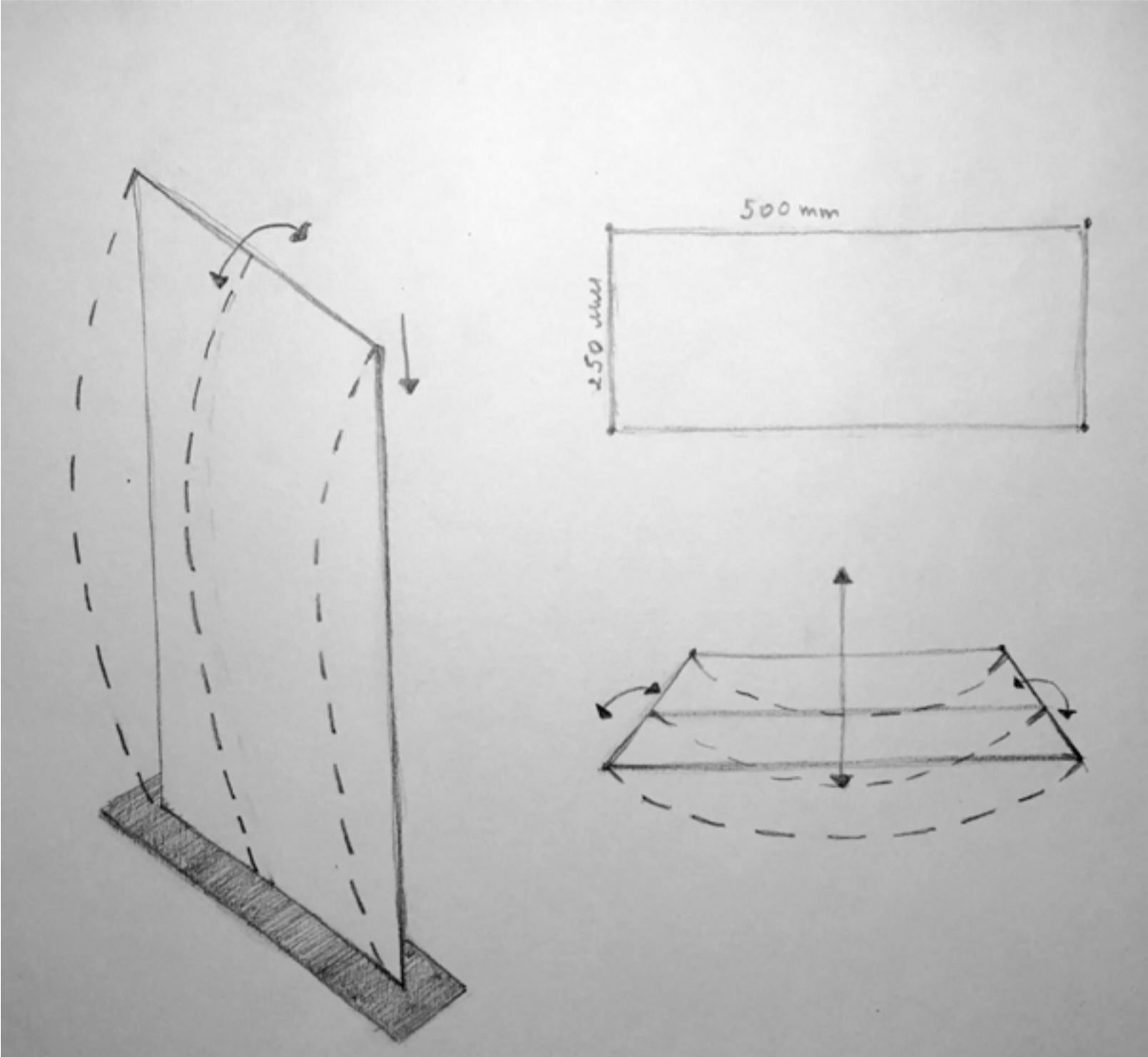

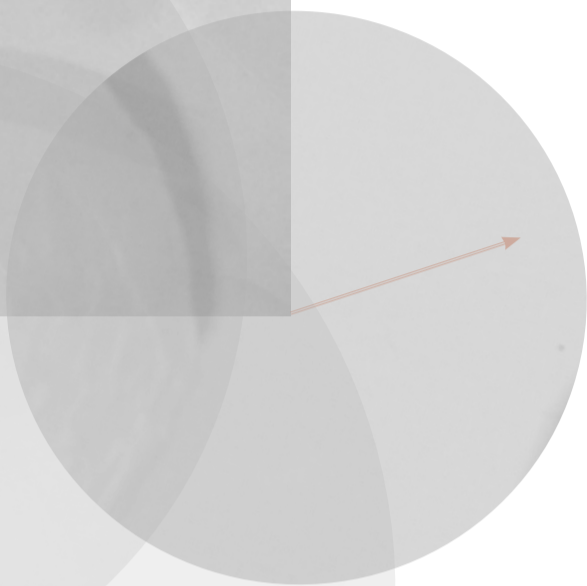
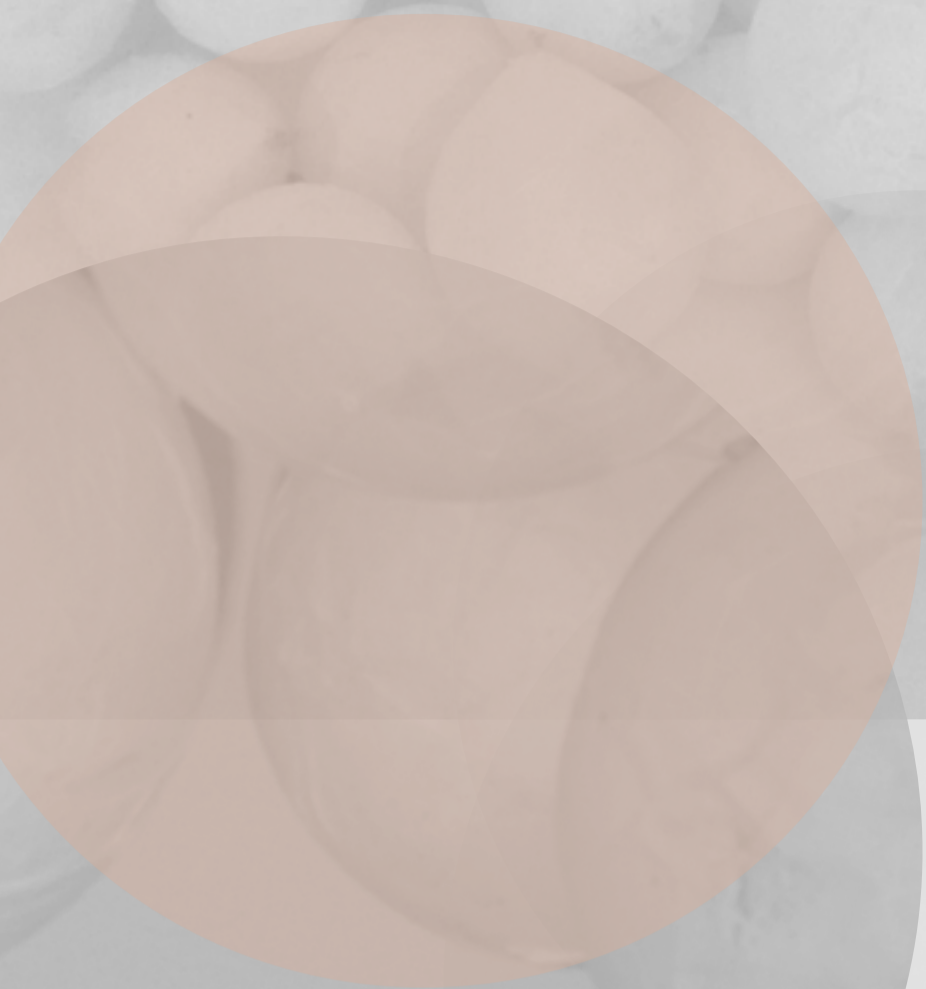

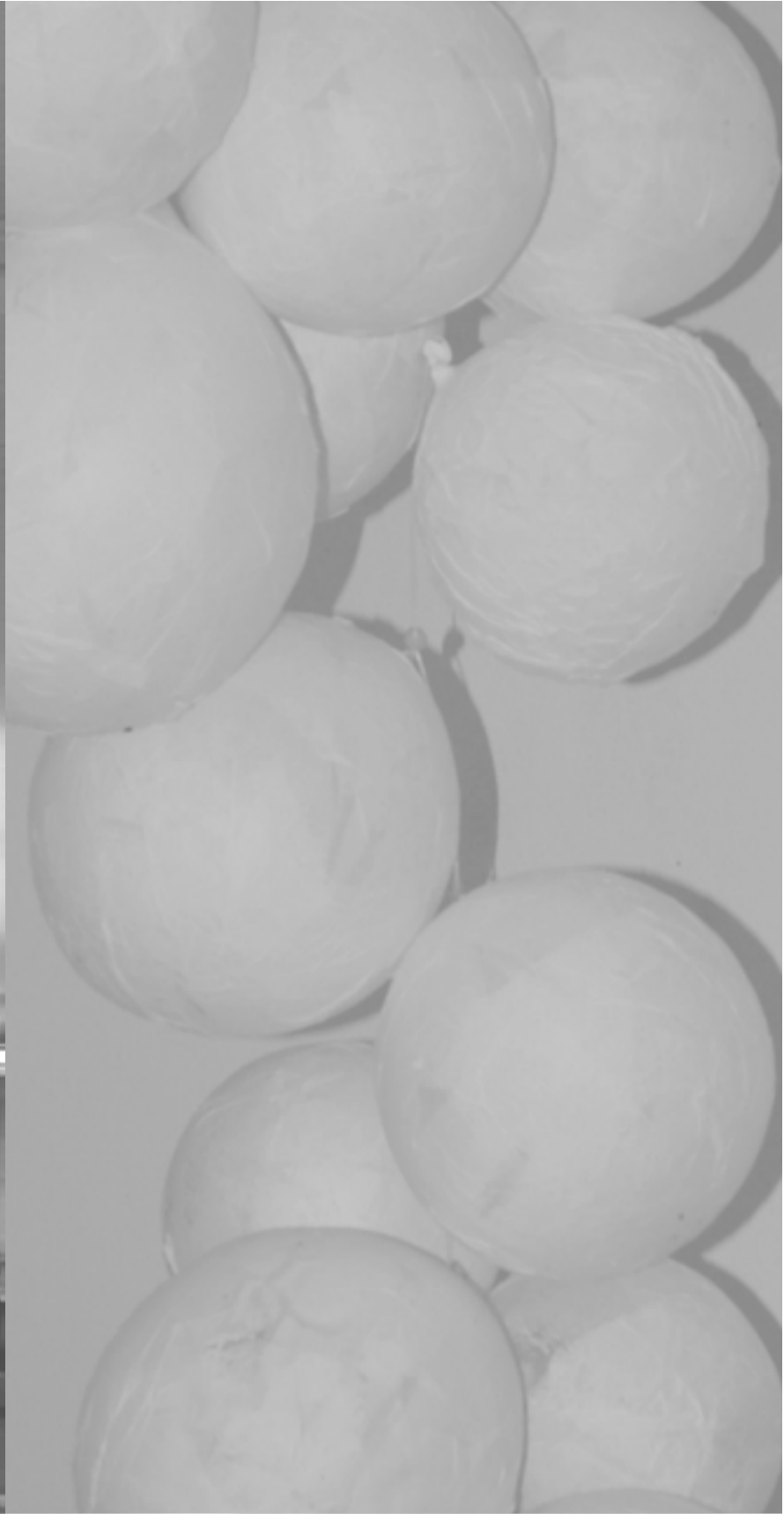

© prozess

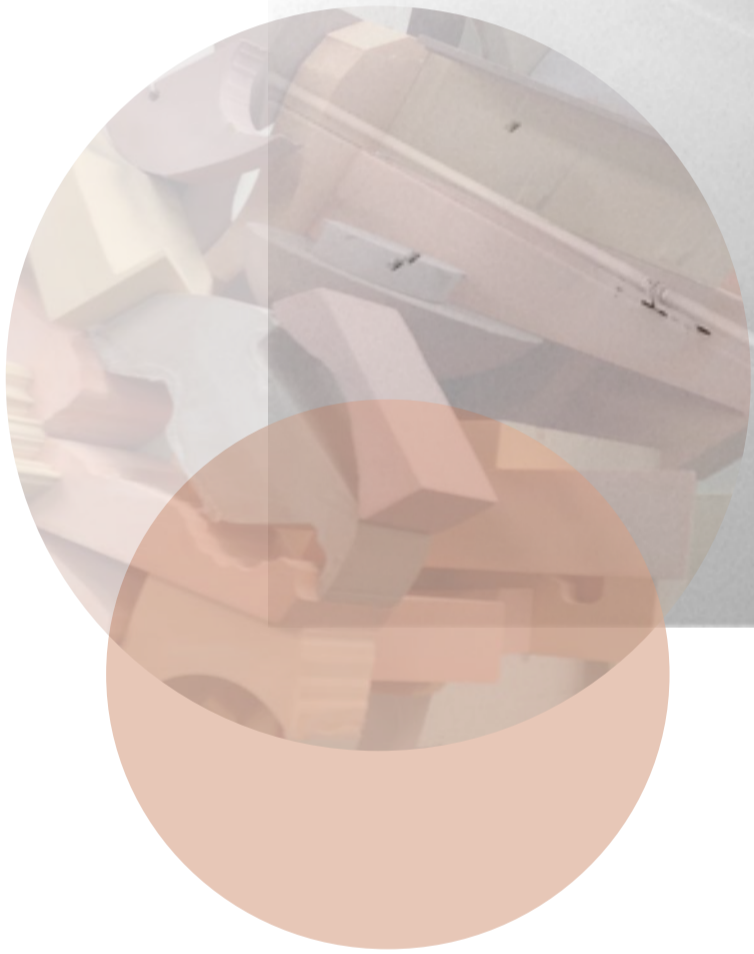

men sich und drehen sich und drehen sich und drehen sich



E I N S ,
Z W E I ,
M E H R





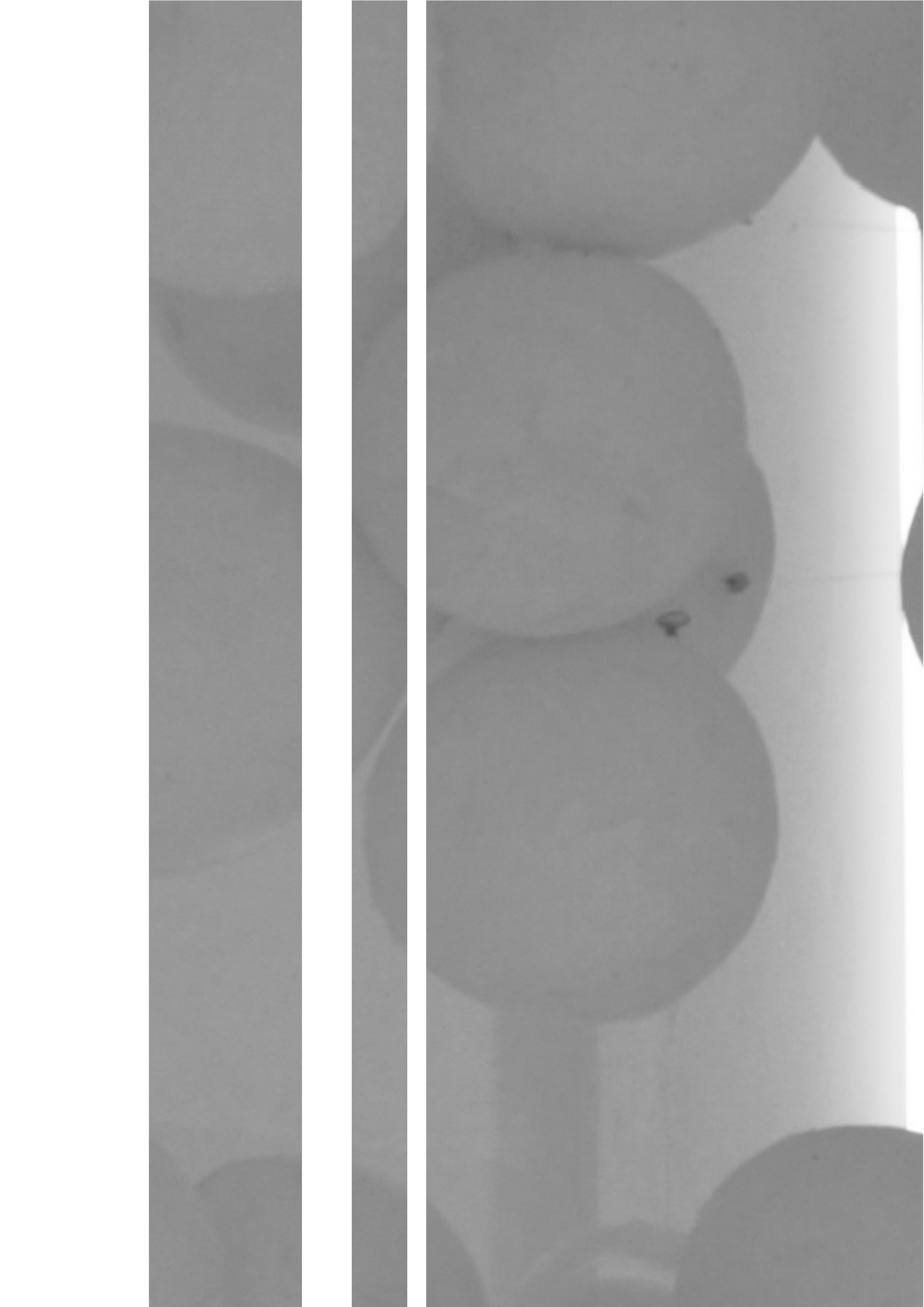

MUSIC FOR INSTRUMENTS

This project defines sound as a vibration Membrane that bonds living world in the same unlimited frequency.

All beings have living force, we unconsciously vibrate at an organic endless frequency until we die.

All life is rhythmic.

From the rise and fall of the sun to the rise and fall of our breath, from the beating of our hearts, to the infinite vibrations that resonate together as a single system.*

Through our throat, we experience *phonetic sound* and create speech, to sophisticatedly communicate----->>>>> language. BUT the frequencies that we also resonate to include heart beats, pressure and temperature levels; we breath oxygen and have a *chemistry* exchange with our environment.

u

s

w

The instrument I am creating is inspired by the nervous system & subtle energy. I Started with the idea of using my body as an interface to trigger soothing sounds. When I think about nice sound I immediately reference birds and nature healing touch. So I recorded sounds from nature like birds, shells and frogs and with help of conductive textiles and electronic programming reproduce them by performing the circuits with my hands

HANDS ARE NOT ONLY HANDS

In the process the project faces the recognition of electronic energy

and circuits. ///// in paralel I read about

holistics // organic energy interests //conductive patterns

body as a holistic membrane of connections

thefollowingpartofthisdocumentationincludesresearchonasubjectofmyinterest.

T h e h e a l i n g t o u c h o f
S O U N D

Its about of connecting the information I have been gathering through my line of research. In my art I focus on beauty of nature and have the urge to create content to interact with it. Somehow.

Sound waves A and B vibrate at the same frequency. When added together, the frequency stays the same while the amplitude is doubled. this maintains the same pitch but gives increased volume.

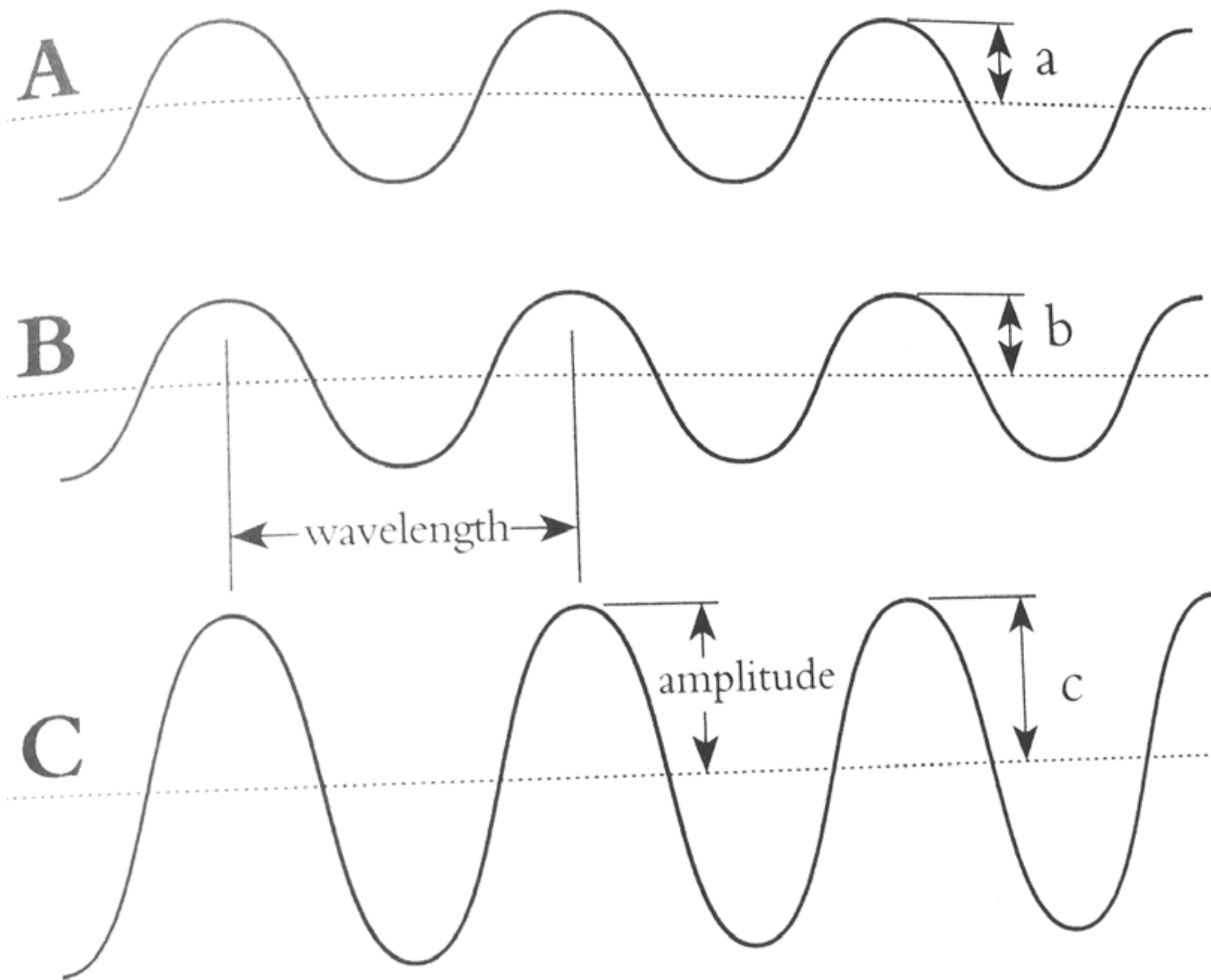

$$a + b = c$$

MUDRA

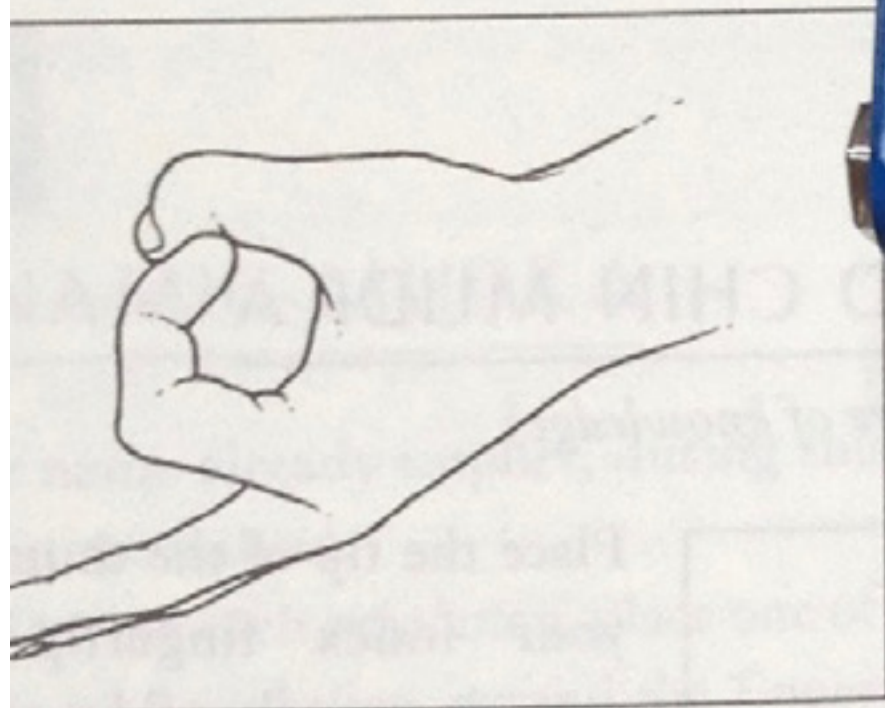

bolize the three *gunas*—traits that keep evolution in both microcosm and macrocosm in motion: *tamas* (lethargy) (activity), and *sattwa*

harmony). The closed circle of the index finger and the... goal of yoga—the unification of *Atman*, the individual soul, and *Brahman*, the world soul.

We find this mudra in many of the Hindu portraits... the right hand is raised... which touch each other... The... *Arka Mudra* (dis... Christ was... in Catholic liturgy the priest makes

and it... you... *Jnana Mudra*... practicing... letting... forward and... here they... of the human... a certain tender-

With... ns... e... ready fir... could... be ove... complaints... no difference whether the *Jnana M*... *Mu*... According to Kesh... w, this m... sal remedy for

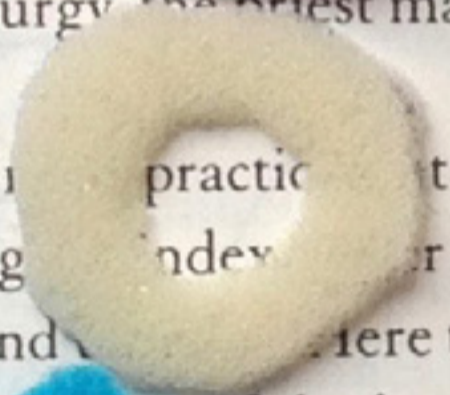

impro
memo
"clear
ness,
with
after
tice a
mudr

associ

Vi
ob
su
be

L

Resonance is a state of synchronization among vibrational patterns. All vibrations can be thought as wave like movements through space and time, each waveform has a characteristic rhythm (known as frequency) that describes how frequently the waves rise and fall. In music, the pitch of a note can be expressed as a certain frequency. When two or more sounds from different sources vibrate at the same frequency, they are said they resonate together. This means their waveforms oscillate back and forth at the same rhythm. When this happens, the height of the waves is added together and the waves lock into phase with each other. Once in phase they tend to remain that way. Oscillating waveforms tend to stabilize when they enter into RESONANCE because they are on the same wavelength. Resonance frequencies tend to bond together. This is also known as sympathetic vibration.

To Play the Instrument for Music

~~The way to play the contacts in the fingers resembles the technique of Mudra Gestures and the performance is inspired by indian ballet. Both traditional disciplines address guided coordination movements between both brain Hemispheres and the extremities of the Body.~~

We experience resonating wave forms in many ways. When we listen to a chorus of voices or a troupe of drummers, we are immersed in a field of resonance that vibrates every cell in our body. Such a field influences the subtler vibrations of consciousness and we feel pleasure, expansiveness and rhythmic connection with the pulse of life itself. We enter even a deeper resonance when we dance or move rhythmically to music. When SOUND actually becomes a rhythmic entertainment of various frequencies within our body and consciousness, forms a coherent, central vibration that we experience as ~~->>BeatFlownSynced? for example when we are having a good day and we seem to be in harmony with everything.~~

~~Understanding the principles of vibration and resonance helps us increase the coherence of our basic vibrational experience and realign our basic rhythm.~~

Resonance requires a certain balance of flexibility and tension. A string needs to be both taut and flexible in order to sound a note. In our bodies as well, we have enough flexibility to resonate with different frequencies, yet maintain enough tension to create repeating PATTERNS



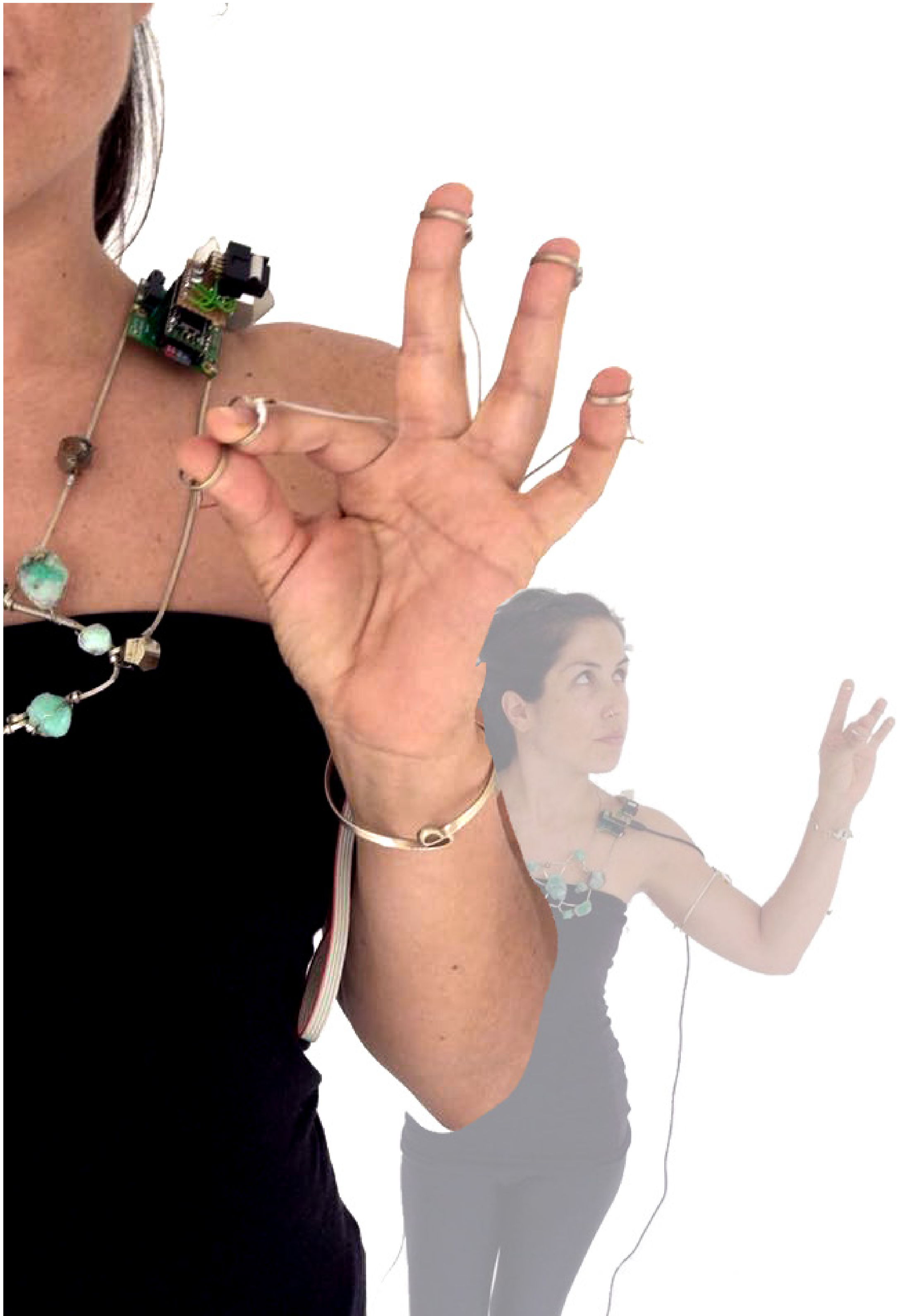

ENTERING THE SYMBOLIC//////////

ARTIST As INSTRUMENT FOR patterned CONCEPT
c r e a t i v e
c y c l e s

Each fingertip has a recorded sound connection triggered by contact with the thumb. It could be any sound or just the subtle touch would be cool to put sensors all around the body and make an instrument really with notes and everything a proper jump-

suit.. *music as i am refering here is probably sophisticated language speech.*

anything has the ability to create sound, but not everything is an instrument to make MUSIC and by the case every human is an artist ONLY when he knows it. until a piece of art is aknowledge as such its logic understood its beauty admired. The ability to observe our behaviour and thoughts, our consciousness, the connectivity of our brain and ideas, difference us from animals all that

n o i s e
probably that is why icaro is healing... it pushes one to resonate to something from the womb from a deep core, and when we dance as well.

At the level of the fifth chakra, our attention moves from the physical plane into the subtle etheric fields. This etheric field is generated by the totality of internal processes-----from the energetic exchange of subatomic particles to digestion of food in our cells, from the firing neurons to our current emotional state, and on to the larger rythms of our outer activities. Our very force can be seen as a stream of pulsating energy. When the stream is not fragmented by blocks in the body armour, then pulsation moves freely through the body and out in the world. this streaming creates a resonant , etheric field around the body--an aura of wholeness, A resonant field makes coherent connections with the outside world. A fragmented field makes fragmented connections.

As we interact with others, our etheric fields become engaged. the most rewarding connections occur when there is resonance between vibrational fields. Just as people who speak the same language resonate with spoken symbols, the subtle

r e s o n a n c e
between our etheric field and those of others deepens our feeling of connection. (attraction to an oldsecret)

anything has the ability to create sound, but not everything is an instrument to make MUSIC when i was recording sounds in the caribbean A/C was so loud. The ability of

observe our behaviour and thoughts, our consciousness, the connectivity of our brain and the healing touch of sound, the energy of attention and the power of the mind. differences us from animals,????? are we better or more present than other beings because we think about it? OPPOSITE thought can abstract us to the point that we are not there anymore but are just placing ourselves virtual-ly by creating different realities through multitasking. why is music healing? when it is made its an ovbious sublimation and when received because it pushes us to resonate to something, Like when we dance as well. anything has the ability to create sound, but not

h a r m o n y
sinfonies as we know them. Sin embargo leyendo sobre el cuerpo como sistema holistico regreso a los centros y puntos energeticos, a la lectura de meridianos y encuentro la importancia del gesto y el uso de la energia sutil. the energy of attention and the power of the mind. The importance of the subtle gesture and the use of the breath to heal, to attune the exchange of energy with the mind (and sometimes hands) and sometimes feet or body parts. Shivanata or Reflexology Tomatote Tomaten, so much to learn so much to observe. TO clear some circuits to

c l e a n s e

and by the case not every human is an artist ONLY until he knows it. The ability of observe our behaviour and thoughts, our consciousness, the connectivity of our brain and thoughts, difference us from animals, is that why mantra is healing? because it pushes us to resonate to an ORganic frequency, or when we dance as well. anything has the ability to create sound, but not everything is an instrument

to make MUSIC is that why music is healing? because it pushes us to resonate to something, or when we dance as well. The importance of the subtle gesture and the use of the breath to heal, to attune the exchange of energy with the

hands and mind Shivanata or Reflexology, so much to learn. and by the case not every human is an artist La obra de arte como extension plastica "visual" de esa energia. and by the case not every human is an artist

H E A L

by the case not every human is an artist ONLY until he knows it. The ability of observe our behaviour and thoughts, our consciousness, the connectivity of our brain and thoughts, difference us from animals, is that why mantra is healing? because it pushes us to resonate to an ORganic



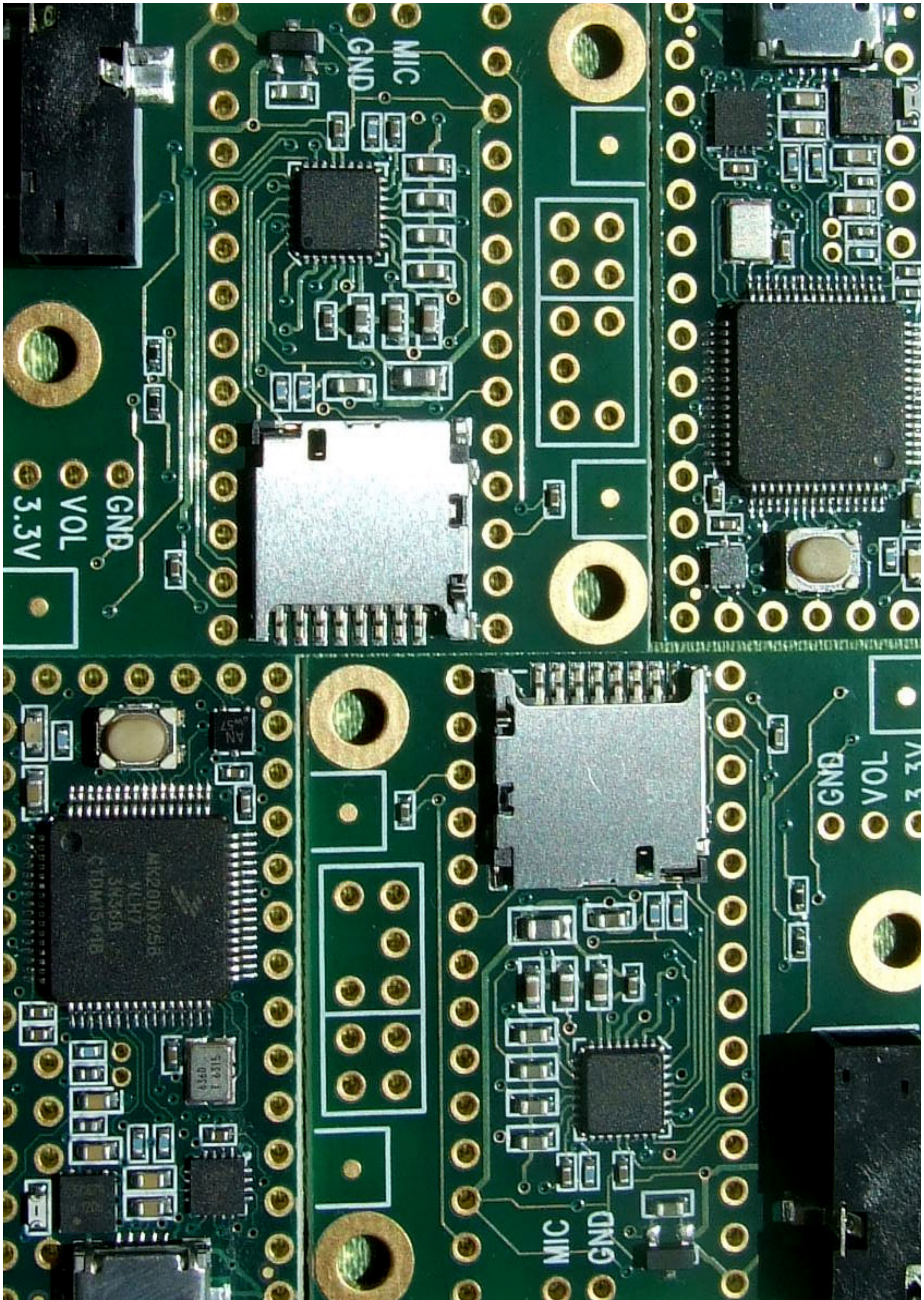

Teppichklang widmet sich der Herstellung von klingenden, geknüpften Oberflächen in Anlehnung an die traditionelle anatolische Teppichkunst.

TEPPICHKLANG





ANG
ANG
ANG





Geknüpft wurde mit einem symmetrischen Knoten - auch türkischer Knoten oder Ghiordes-Knoten genannt - bei dem das zu knüpfende Material in einer Schlaufe um jeweils zwei Kettfäden gelegt wird. Dieser gibt dem Teppich bei der Benutzung von gröberem Material einen besonders guten Halt.





Durch die Verwendung von "lautem" Material, das an sich einen Klang hat oder durch Berührung zum klingen kommt, sind verschiedene Oberflächen aus Papier, Naturbast, Beutelklemmen und Schrauben aus Edelstahl entstanden. Das Material wird hier als Garn oder Schussmaterial eingesetzt. Als Untergrund wurde Jute und klassischer Teppichstramin benutzt.

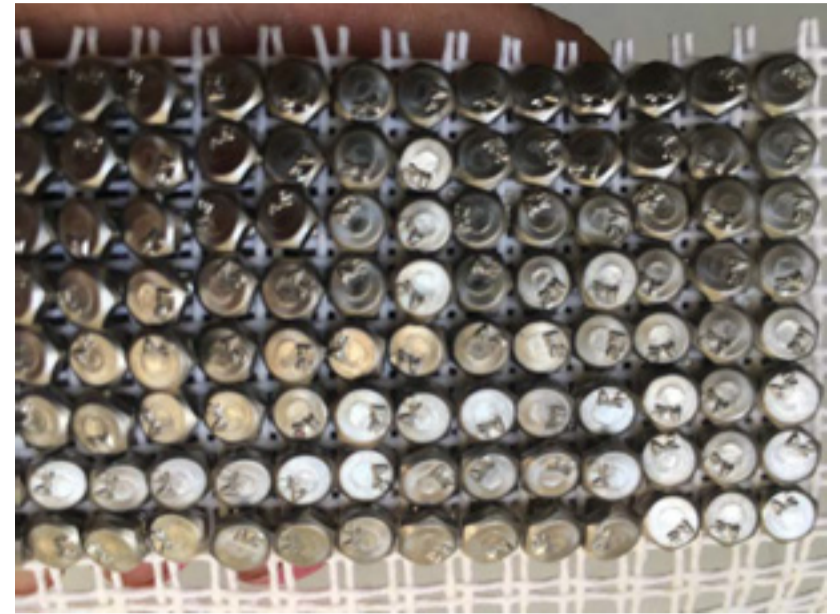



SCHELLEN

CAN LUKAS DEMIR

EIN PRALL – EIN SCHALL – DICHT AM GESICHT -
VERLOREN IST DAS GLEICHGEWICHT.

SO TÖRICHT IST DER MENSCH. - ER STUTZT,
SCHAUT DÄMISCH DREIN UND IST VERDUTZT,
ANSTATT SICH ERST MAL SOLCHE SACHEN
IN ALLER RUHE KLARZUMACHEN. -

HIER STROTZT DIE BACKE VOLLER SAFT;
DA HÄNGT DIE HAND, GEFÜLLT MIT KRAFT.
DIE KRAFT, INFOLGE DER ERREGUNG,
VERWANDELT SICH IN SCHWUNGBEWEGUNG.
BEWEGUNG, DIE IN SCHNELLEM BLITZE
ZUR BACKE EILT, WIRD HIER ZU HITZE.
DIE HITZE ABER, DURCH ENTZÜNDUNG
DER NERVEN, BRENNT ALS SCHMERZEMPFINDUNG
BIS IN DEN TIEFSTEN SEELENKERN,
UND DIES GEFÜHL HAT KEINER GERN.

OHRFEIGE HEIBT MAN DIESE HANDLUNG,
DER FORSCHER NENNT ES KRAFTVERWANDLUNG.



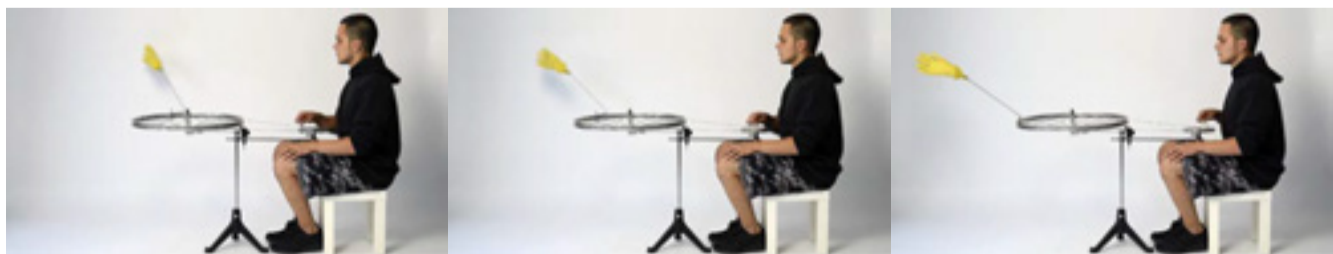

GEDÄCHTNISSTÄRKUNG
RRRING

ERZIEHUNGSMITTEL
RRRING

EHRENBELEIDIGUNG
RRRING

FEEDBACK

Feedback ist eine Rückmeldung auf eine Aktion. Doch was ist das Gegenteil von eben dieser? Was wäre wenn das Spiegelbild von Narziss antwortet und die Kommunikation auf Ablehnung beschränkt ist?

Es ist ein Projekt welches sich selbst negiert und den Betrachter auf eine Reise zwischen Interaktion, Chaos und Antwort schickt.

FEEDBACK ist eine Sound-Installation, die auf der Idee basiert, Ton, Technik, interaktive und ästhetische Komponenten zu verbinden.

Doch in allen Bereichen dieser Arbeit ist die Rückmeldung disharmonisch.

Der Besucher stellt sich seinem verzerrten Spiegelbild und ist dazu aufgefordert, lautstark mit Diesem zu kommunizieren.

Zwei Sound-Sensoren reagieren abwechselnd auf den akustischen Input, und steuern somit die Abfolge des Sounds, der sich dem Betrachter durch mehrere, in verschiedenen Emotionen gesprochene „NEIN“s bemerkbar macht. Das dritte Sensor - Soundmodul gibt einen Text von dem dritten Buch der Metamorphosen von Ovid wieder. Es wird monologisiert und richtet sich so nicht direkt an den Zuhörer. Hiermit verbindet sich die Geschichte von Narziss, der sich in die Reflektion seines Abbildes verliebte, mit dem Ende des Dialoges durch das kreisen um sich selbst und die folgende Abgrenzung von der Außenwelt.

Es wird jeglicher Austausch verhindert und es entsteht ein Ablehnung signalisierendes Feedback.

Die Interaktion besteht dabei insofern, als dass Länge und Lautstärke des Inputs die Qualität des Outputs beeinflusst.

Der technische Aufbau und die Software funktionieren in sich geschlossen. Der Output erzeugt, durch die eingebaute zeitliche Verzögerung, ein Gefühl der Unzuverlässigkeit und der Verwirrung.

FEEDBACK zeigt uns eine Situation, wie wir sie oft in unserem alltäglichen Leben vorfinden. Ein Scheitern an der Kommunikation. Oder auch die bewusste Ablehnung anderer Meinungen, Aussagen und Ideen.

Das Projekt Feedback wirft zudem die Fragestellung auf, was geschieht, wenn wir an dem Medium Sprache scheitern.

Kann durch das Misslingen Neues entstehen und aus Ablehnung/Negation eine positive Reaktion erzeugt werden ?

Ist Ablehnung schon immer ein Bestandteil unseres Lebens?

Ist Negation ein Abwehrmechanismus?

Ist das Nein sagen können eine Stärke?



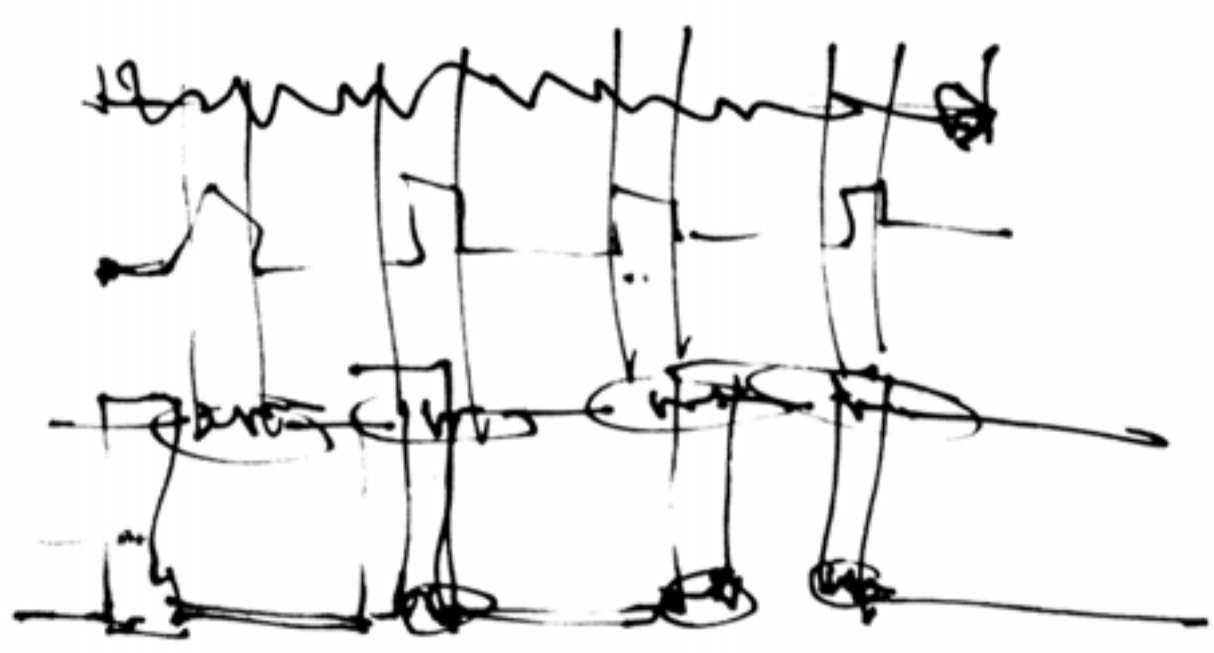
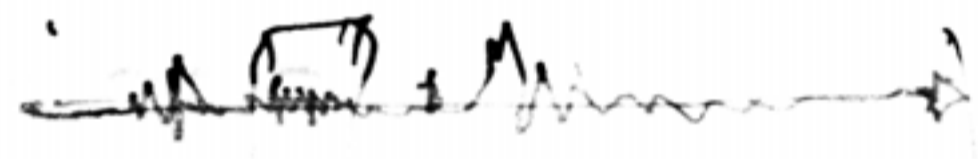
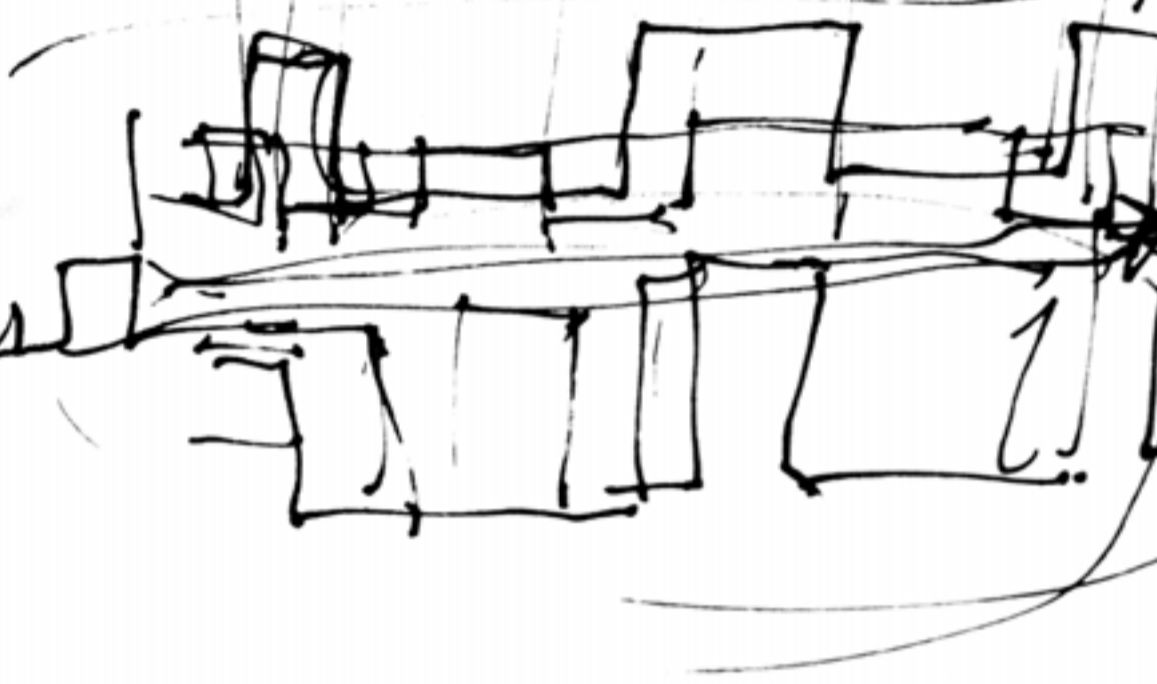
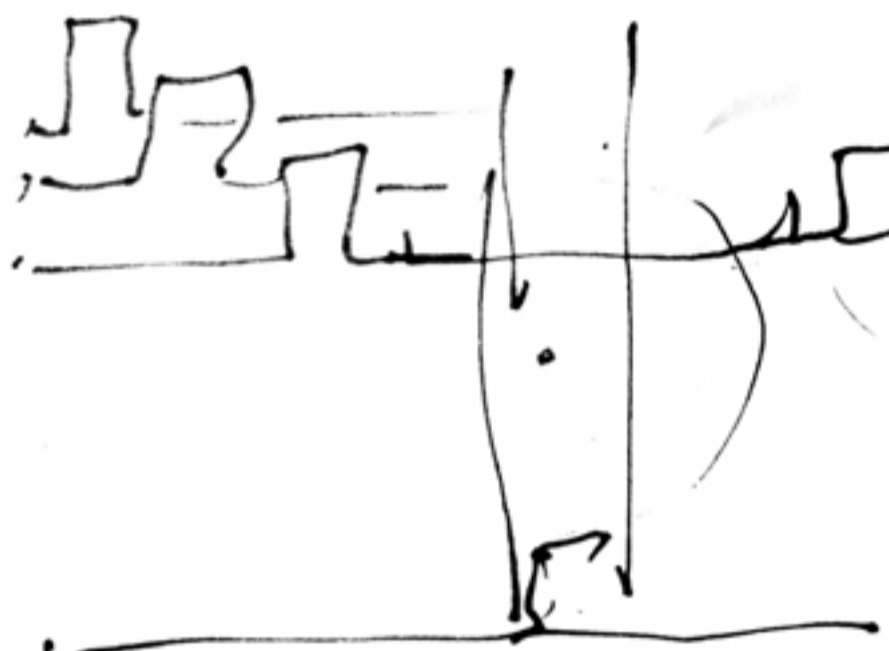
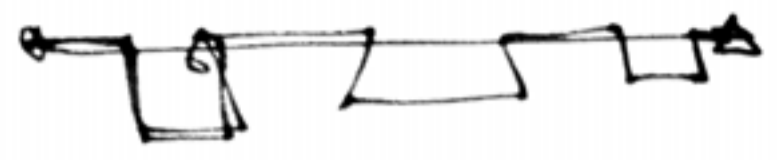
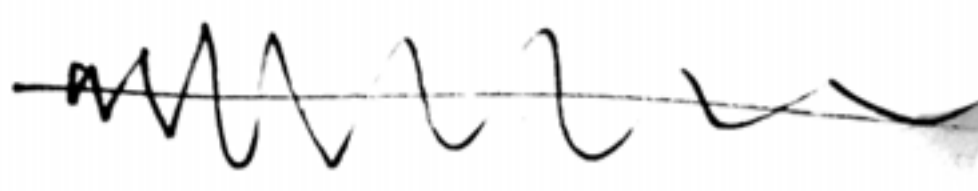

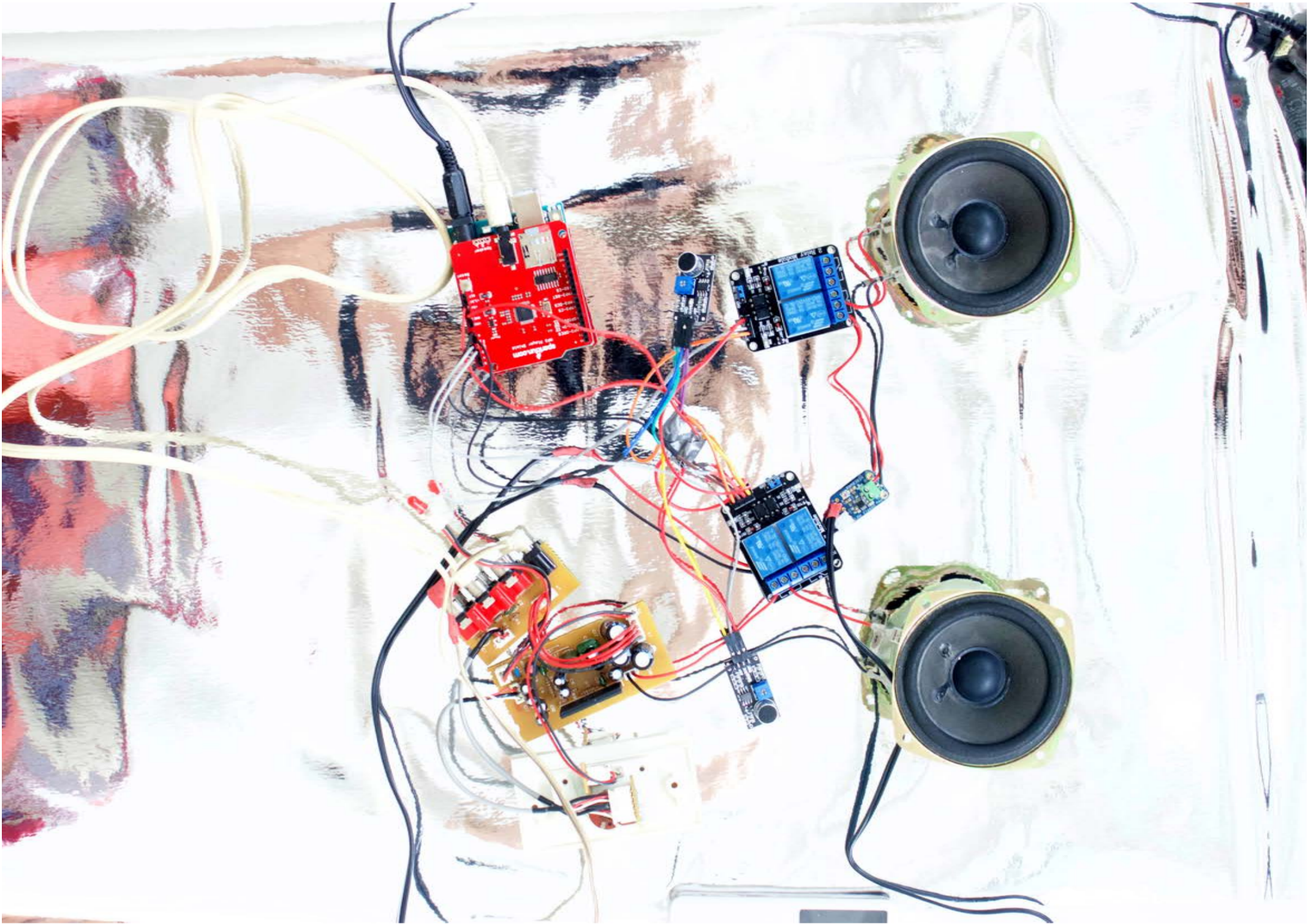

nein nein nein nein
nein nein nein nein nein
neeeeeeeeeiiiiinnnnn
nein nein nein nein
nein nein nein nein nein
neeeeeeeeeiiiiinnnnn
nein nein nein nein
nein nein nein nein nein
neeeeeeeeeiiiiinnnnn
nein nein nein nein
nein nein nein nein nein
neeeeeeeeeiiiiinnnnn
nein nein nein nein
nein nein nein nein nein
neeeeeeeeeiiiiinnnnn

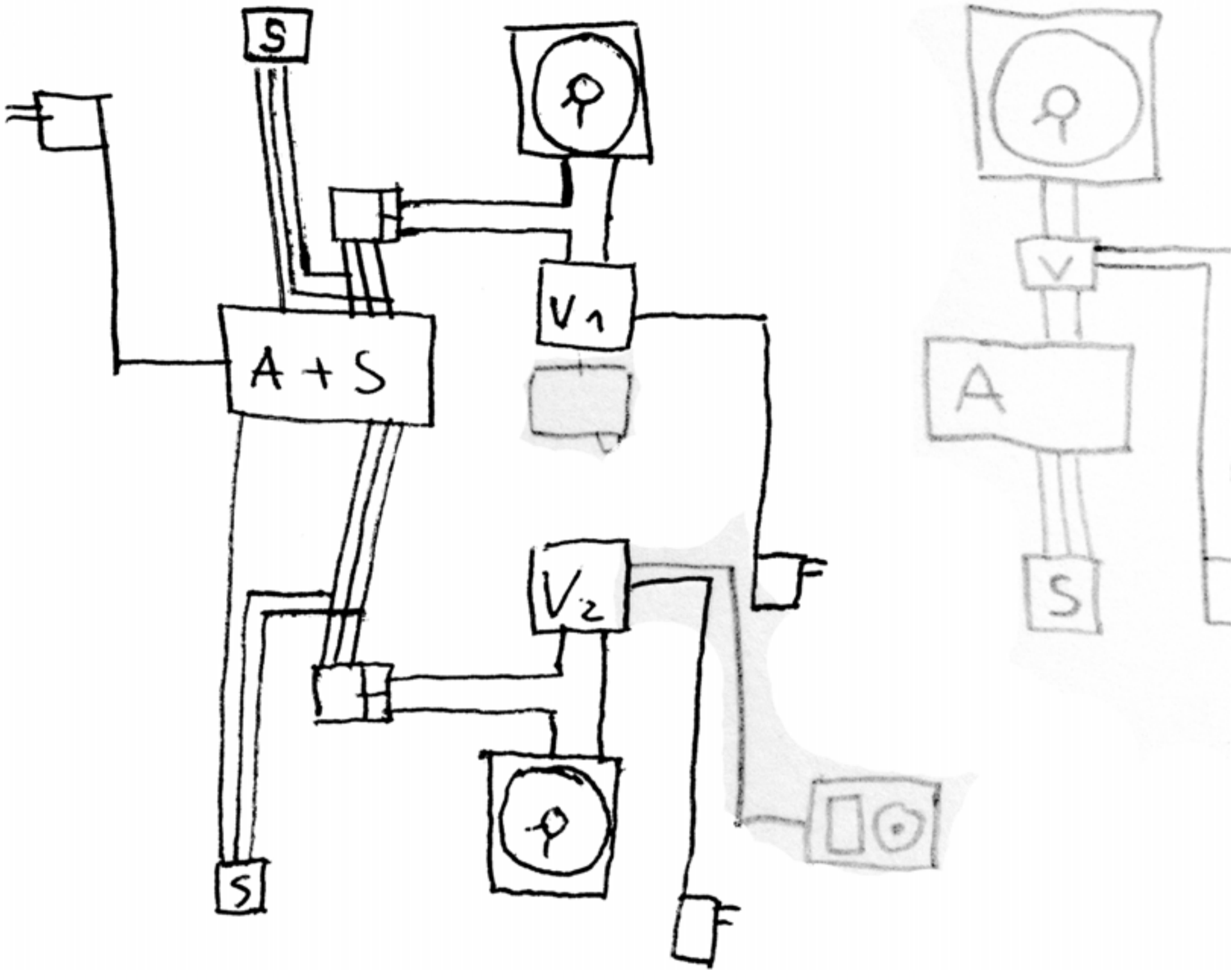



sketch_jul05bfinal | Arduino 1.6.10 Hourly Build 2016/05/16 05:13

```
sketch_jul05bfinal
```

```
Serial.begin(9600);

//start the shield
sd.begin(SD_SEL, SPI_HALF_SPEED);
MP3player.begin();

//start playing track 1
MP3player.playTrack(1);
}

void loop() {
  unsigned long currentTime = millis();
  unsigned long elapsedTime = currentTime - startTime;
  if (elapsedTime % 1000 == 0)
  {
    Serial.println("----- MODE: " + String(mode) + " ----- time elapsed: "+
    Serial.println("Keyframes 1:");
    for (int i = 0; i < maxKeyFrames; i++)
    {
      Serial.print(i);
      Serial.print("/");
      Serial.print(counter1);
      Serial.print(": ");
      Serial.println(keyFrames1[i]);
    }
  }
}
```

Speichern abgeschlossen.

```
at cc.arduino.packages.discoverers.NetworkDiscovery.inetAddressAdded(NetworkDiscovery
at cc.arduino.packages.discoverers.network.NetworkChecker.run(NetworkChecker.java:67)
at java.util.TimerThread.mainLoop(Timer.java:555)
at java.util.TimerThread.run(Timer.java:505)
```

9 Arduino/Genuino Uno auf /dev/cu.usbmodem1421





Doch wie den Durst er zu stillen begehrt, erwächst ihm ein anderer Durst: beim Trinken erblickt er herrliche Schönheit; ergriffen Liebt er ein Körperlos Schemen: was Wasser ist, hält er für Körper. Reglos staunt er sich an, mit unbeweglichem Antlitz, Starr, einer Statue gleich, die aus parischem Marmor geformt ist. Liegend am Boden erschaut er das Doppelgestirn seiner Augen, Sieht seine Haare - sie hätten Apollo geziert oder Bacchus -, Sieht die Wangen der Jugend, den Hals, der wie Elfenbein schimmert, Seinen so zierlichen Mund und die Farbe von Schnee und von Rosen. Alles bewundert er jetzt, weshalb ihn die andern bewundern: Sich begehrt er, der Tor, der Liebende ist der Geliebte, Und der Ersehnte der Sehrende, Zunder zugleich und Entflammter. (III, 415- 426) Ovid ,drittes Buch der Metamorphosen

nein nein nein nein nein
 nein nein nein nein nein
 neeeeeeeeeiiiiinnnn
 nein nein nein nein nein
 nein nein nein nein nein
 neeeeeeeeeiiiiinnnn
 nein nein nein nein nein
 nein nein nein nein nein
 neeeeeeeeeiiiiinnnn
 nein nein nein nein nein
 nein nein nein nein nein
 neeeeeeeeeiiiiinnnn



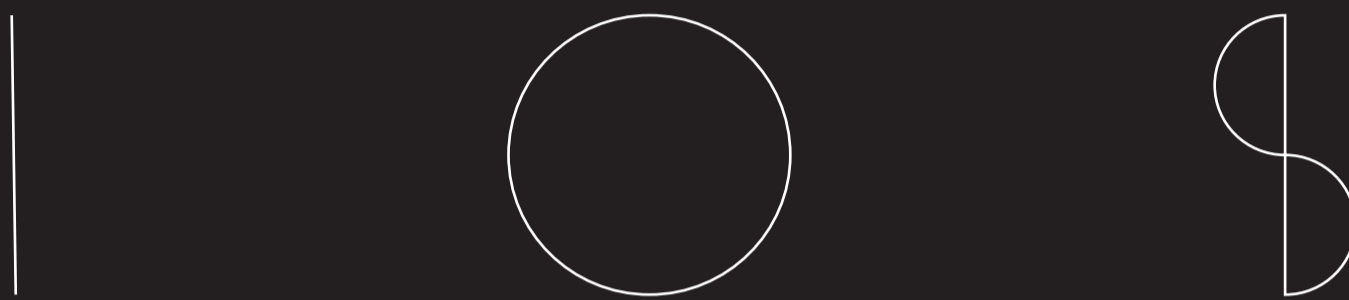

Das Herantasten an die Schallmauer - Mit „Linear“, „Kreis“ und „Linear/S“ will das Pfeiffen zum Knallen gebracht werden. Simon Ertl/SS 2016

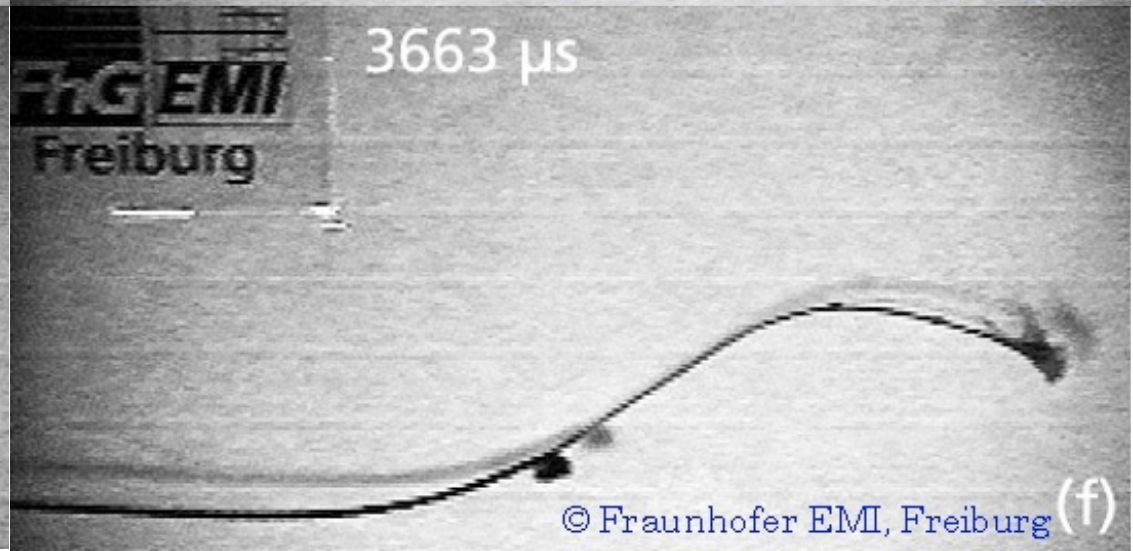
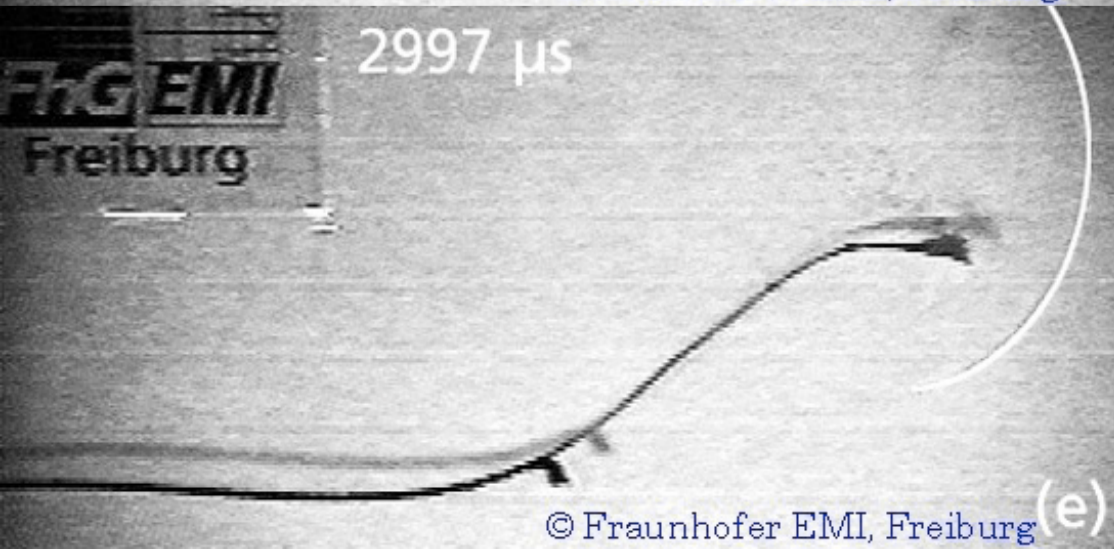
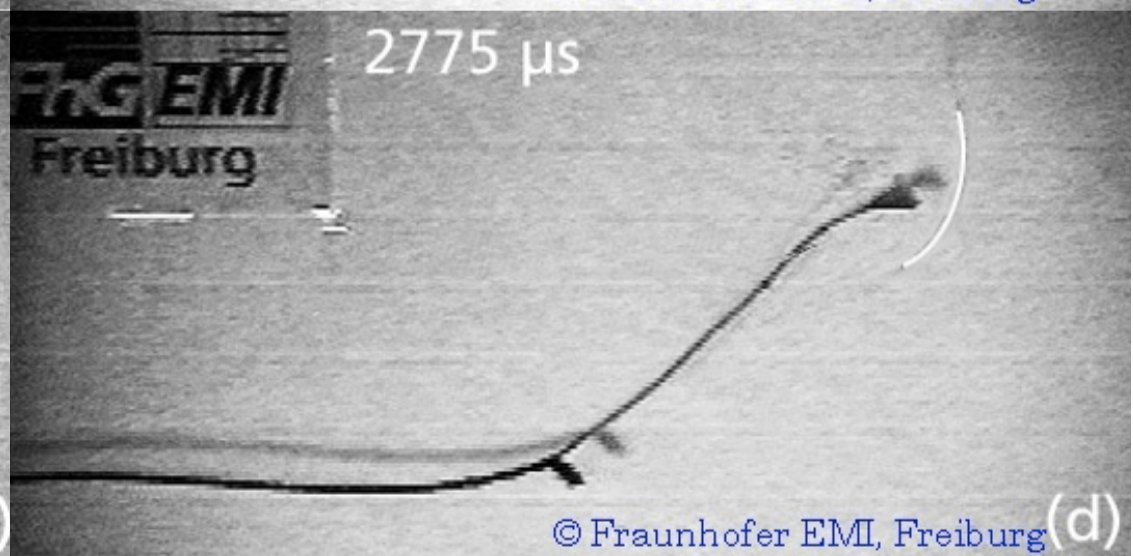
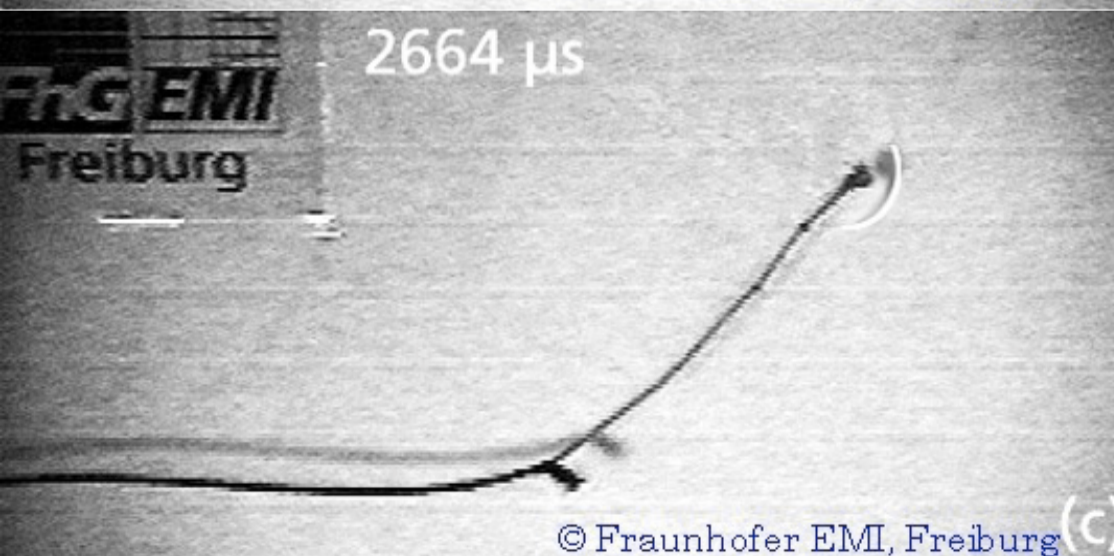
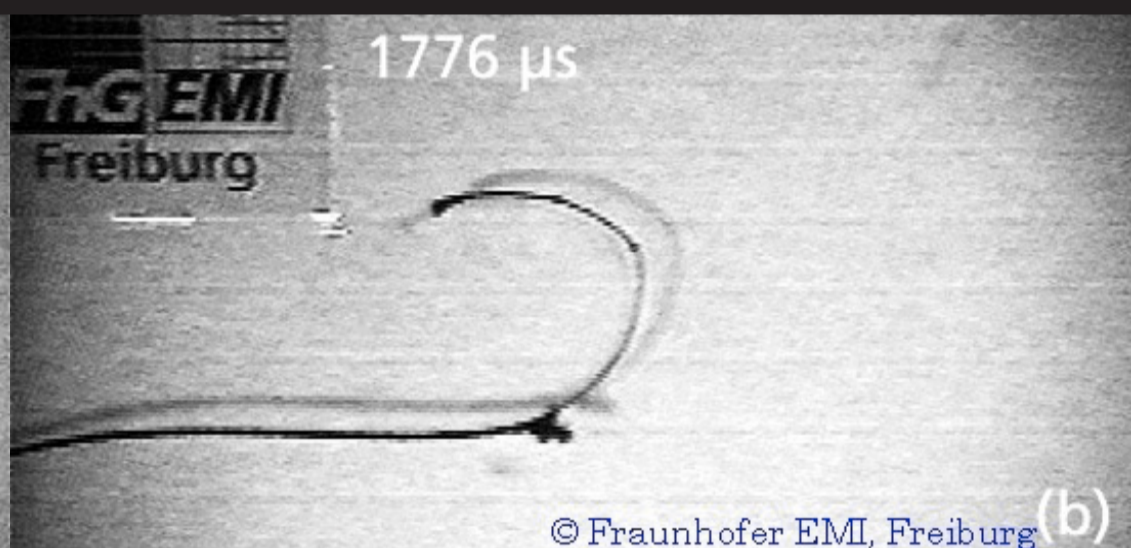



„Ich“ und das Werk sehen
einander ins Gesicht. KLEE

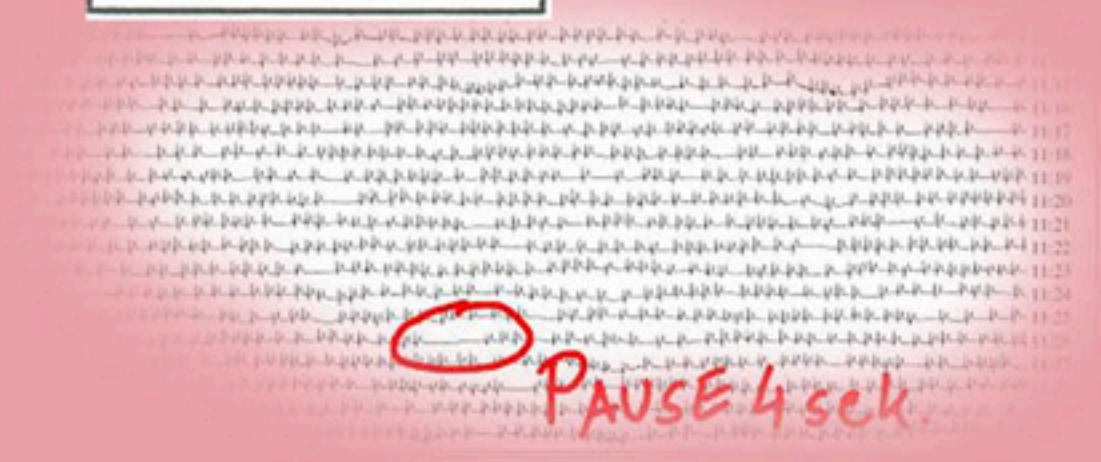

RAUM FÜR DICH

by tau Pibernat

A scenic landscape photograph featuring a large, leafy tree in the foreground on the left. A path leads from the bottom center towards a calm lake in the background. The sun is positioned behind the tree, creating a bright sunburst effect with rays of light. The sky is a clear, bright blue. The overall scene is peaceful and natural.

"ONE OF THE THINGS ABOUT ART IS THAT IT OFFERS YOU A SAFE PLACE FOR YOU TO HAVE QUITE EXTREME AND RATHER DANGEROUS FEELINGS. AND THE REASON YOU CAN DO THAT IS BECAUSE YOU KNOW YOU CAN SWITCH IT OFF; SO ART HAS A KIND OF ROLE THERE AS A SIMULATOR. IT OFFERS YOU THESE SIMULATED WORLDS."

BRIAN ENO, JOHN PEEL LECTURE, 2015

RAUM FÜR DICH IS A CERAMIC SOUND INSTRUMENT THAT PRESENTS AN INTROSPECTIVE EXPERIENCE THROUGH MOVEMENT, NOISE AND TEXTURE.

TRADITIONALLY, THE MOON CAN BE A SATELLITE TO OBSERVE IN SOLITUDE. THE INSTRUMENT REMINISCES TO THE SHAPE OF THE MOON. ITS INSPIRATION LAYS IN THE IDEA OF A SECLUDED SPACE FOR INDIVIDUAL REFLECTION. THE NOTION OF THE TIME AND THE SPACE EACH PERSON NEEDS FOR CONTEMPLATIVE PURPOSES CAN VARY LARGELY, DEPENDING ON CULTURAL AND PERSONAL BACKGROUND. THE AMOUNT OF SPACE AND TIME THAT AN INDIVIDUAL CAN AFFORD TO DEDICATE TO THEM, BECOMES NOT ONLY A CULTURAL MATTER, BUT ALSO A DISCUSSION ABOUT CLASS AND PRIVILEGE.

RAUM FÜR DICH IS ALSO THE RESULT OF A RESEARCH ABOUT THE CERAMIC MATERIAL. THE EXPERIMENTAL STATES INCLUDE FINGER-FITTED INSTRUMENTS, CERAMIC TUBES AND A RAINSTICK.

THE END PIECE IS A CERAMIC BOWL WITH ORGANIC VOLUMES THAT FIT COMFORTABLY IN THE PERFORMER'S HANDS. A SET OF CERAMIC BALLS CAN BE TOSSED INSIDE THE BOWL AND CAN BE SLID, HIT OR STROKED AGAINST ALL OF THE BOWL'S SURFACES TO PRODUCE DIFFERENT SOUNDS. WITH A SONORITY SOMEWHAT SIMILAR TO THAT OF A MARBLE, THE CERAMIC CAN TICK AND CLICK IN A SET OF INTERESTING RHYTHMS.

RAUM FÜR DICH OFFERS A SPACE FOR CONCENTRATION AND OBSERVATION. IT INSTIGATES TO GIVE A PERFORMANCE BY AND FOR ONESELF OR FOR A SMALL GROUP OF PEOPLE THAT CAN ALSO WATCH THE BOWL AND THE CERAMIC BALLS AT THE SAME TIME.



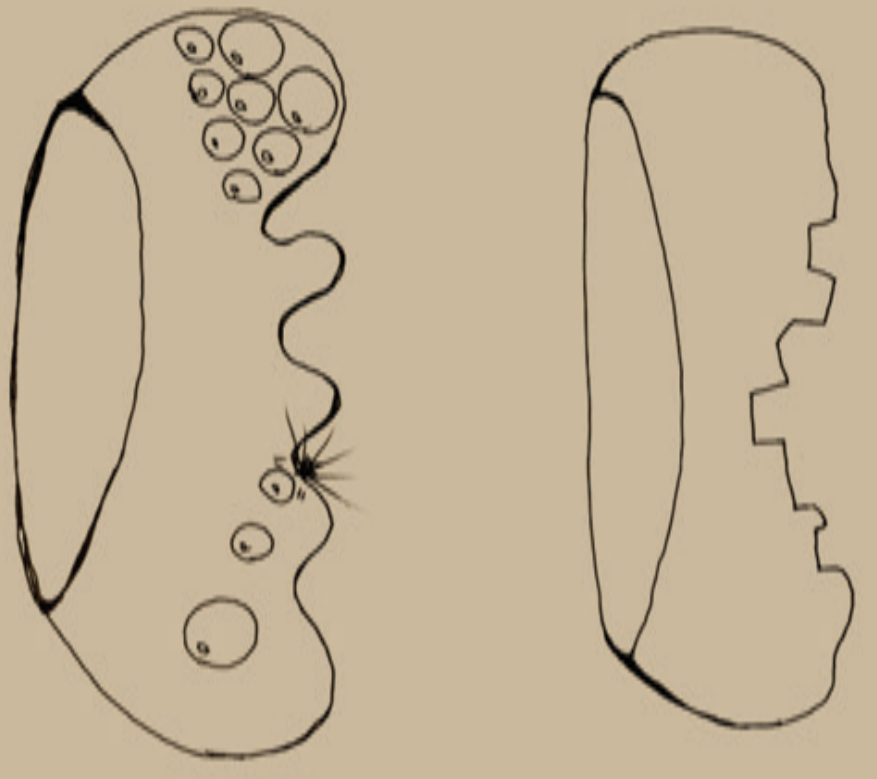
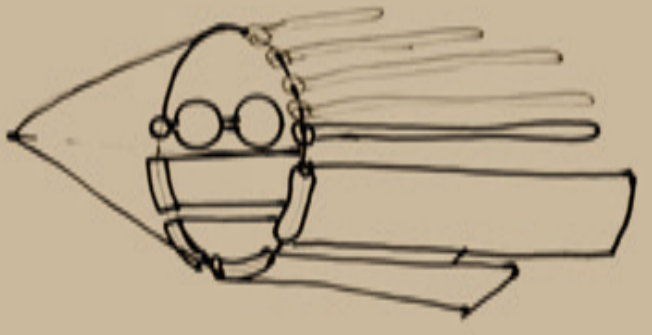
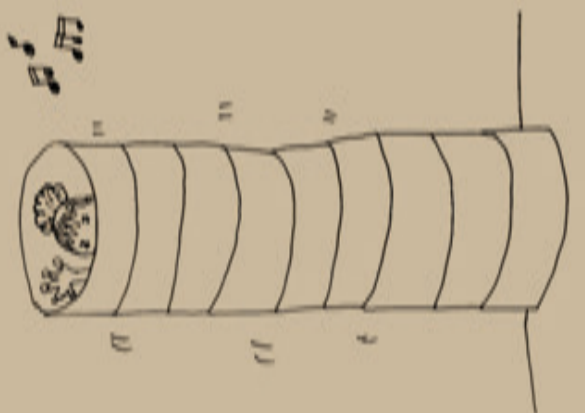
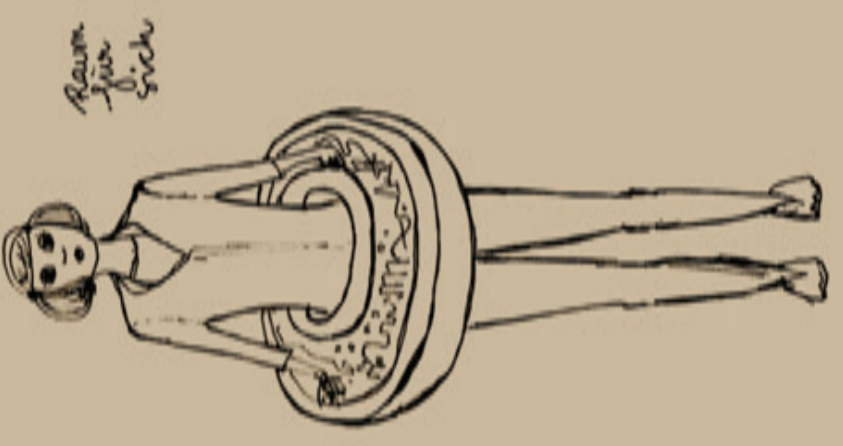
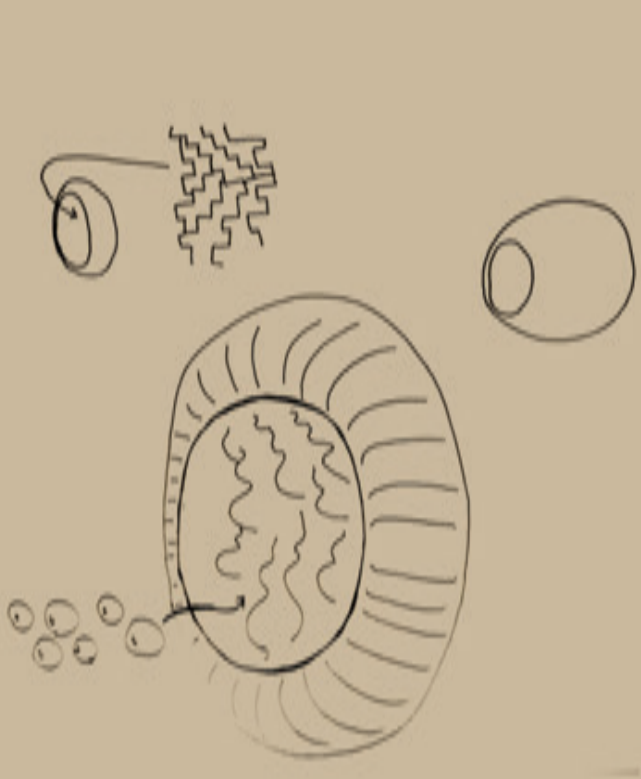
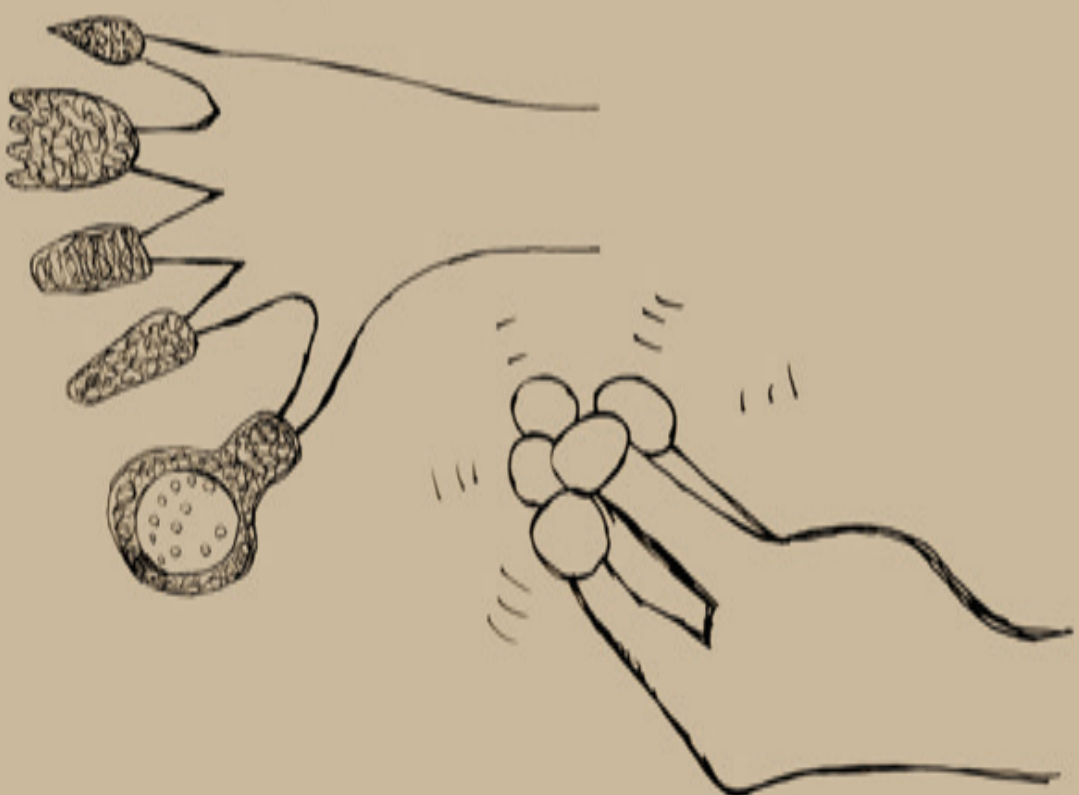



i will sit right down
waiting for the gift of sound and vision
and I will sing
waiting for the gift of sound and vision
drifting into my solitude
over my head

don't you wonder sometimes
'bout sound and vision?

© 2016

© 1977 sound & vision lyrics by david bowie
